

Contents:

Safety instructions:	1	Load Default Parameters:	2
Technical data:	1	Special Functions	2
Mounting	1	Indications On The Display	2
Electrical Installation	2	Alarm Codes and Messages	2
Setup and Parameter Modification		Parameter List	3
using the Keypad	2	Visualising Data: WebPages	4
Temporary Display of Data:	2		

Note: This document contains short form instructions for experienced users. Use last column in List of Parameters to document your individual settlings. More detailed information can be found in the User Manual.



The EC3-332 is a dedicated controller for refrigerated coldrooms with superheat control and a driver for an Alco Controls Electrical Control Valve EX5...EX8. In addition the EC3-332 controls air temperature and manages defrost and fan(s).

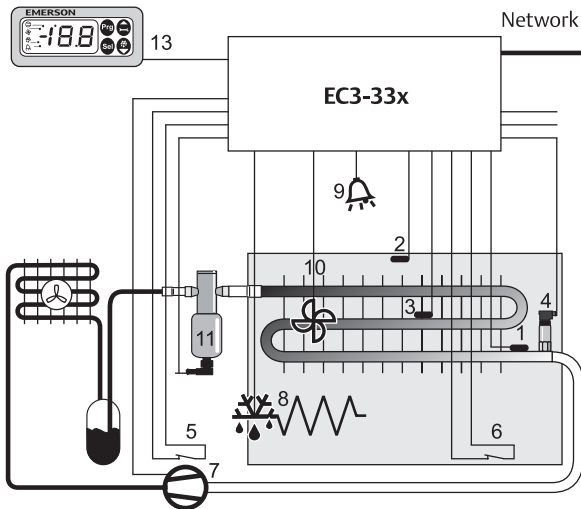

A PT4 pressure transmitter (4) and an ECN-Pxx pipe temperature sensor (1) measure saturated suction gas pressure and suction gas temperature at the evaporator outlet and feed the signals into the superheat control loop. The superheat controller output modulates the opening of the EX5...EX8 Electrical Control Valve (11) thus optimising the refrigerant mass flow through the evaporator. The ECN-Sxx air temperature sensor (2) measures air-in temperature at the evaporator and feeds a signal into the air temperature thermostat. The ECN-Fxx fin sensor (3) is used for defrost termination. Digital input (5) should be connected to the serial control loop of a compressor (where applicable) and digital input (6) should be connected to the coldroom door contact. The controller has 4 relay outputs to control the compressor (7), defrost heater (8) evaporator fan (10) and an external alarm device (9). Please consult the technical data (right) for input and output ratings.

The EC3-332 features an integral backup battery to close the electrical control valve in case of power loss. Due to the positive shut-off characteristics of the EX5...EX8 Electrical Control Valves, a liquid line solenoid valve is not needed to prevent flooding of the compressor.

The optional ECD-001 Display Unit (13) can be connected to the EC3-332 for local display of control parameters and for controller setup without the use of a PC. Because the EC3-332 is fully functional without display unit the ECD-001 may be removed at any time.



Safety instructions:

- Read installation instructions thoroughly. Failure to comply can result in device failure, system damage or personal injury.
- The product is intended for use by persons having the appropriate knowledge and skills.
- Ensure electrical ratings per technical data are not exceeded.
- Disconnect all voltages from system before installation.
- Keep temperatures within nominal limits.
- Comply with local electrical regulations when wiring
- The EC3 series contains a lead, acid gel rechargeable battery. The battery must NOT be disposed of with other commercial waste. Instead, it is the users responsibility to pass it to a designated collection point for the safe recycling of batteries (harmonised directive 98/101/EG). For further information, contact your local environmental recycling centre.

Technical Data

EC3 Series Controller

Power supply	24VAC ±10%; 50/60Hz; Class II 6.3mm spade earth connector
Power consumption	28VA max including EX5 ... EX8
Communication	RJ45 TCP/IP Ethernet 10MBit/s
Plug-in connector size	Removable screw terminals wire size 0.14 ... 1.5 mm ²
Temperature storage	-20 ... +65°C
operating	0 ... +60°C
Humidity	0...80% r.h. non condensing
Protection class	IP20
Pressure transmitter input	24VDC, 4...20mA
Analog output	24VDC, 4...20mA
Digital Inputs	24VAC/DC
Output relays	(2) SPDT contacts, AgCdO (2) SPST contacts, AgCdO Inductive (AC15) 250V/2A Resistive (AC1) 250V/8A
Stepper motor output	For EX5...EX8 Electrical Control Valves

ECD-001 Display Unit

Power Supply	From EC3-332 via connecting cable
Display	2½-digit red LED with decimal point switchable between °C and °F
LED indicators	Compressor, Fan, Defrost, Alarm, IR status
Temp & Humidity	Identical to EC3-332 specifications above
Protection class	IP65 (front protection with gasket)
Connecting cable	ECC-017 (1,5m) or CAT5 cable with RJ45 connectors

Mounting

The EC3-332 is designed to be mounted onto a standard DIN rail.

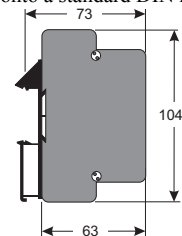
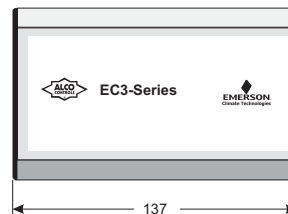

The ECD-001 can be mounted in panels with a 71 x 29 mm cutout. See dimensional drawing below for space requirements including rear connectors.

Push controller into panel cutout.(1)
Make sure that mounting lugs are flush with outside of controller housing

Insert allen key into front panel holes and turn clockwise. Mounting lugs will turn and gradually move towards panel (2)

Turn allen key until mounting lug barely touches panel. Then move other mounting lug to the same position (3)

Tighten both sides very carefully until controller is secured. Do not over tighten as mounting lugs will break easily.



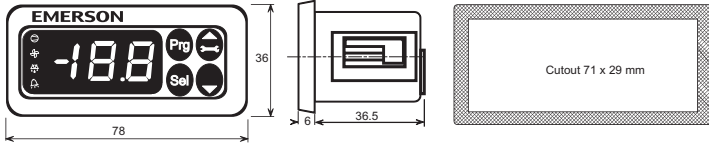

Electrical Installation

Refer to the electrical wiring diagram (below) for electrical connections. A copy of this diagram is labeled on the controller. Use connection wires/cables suitable for 90°C operation (EN 60730-1). Ground the metal housing with a 6.3mm spade connector.

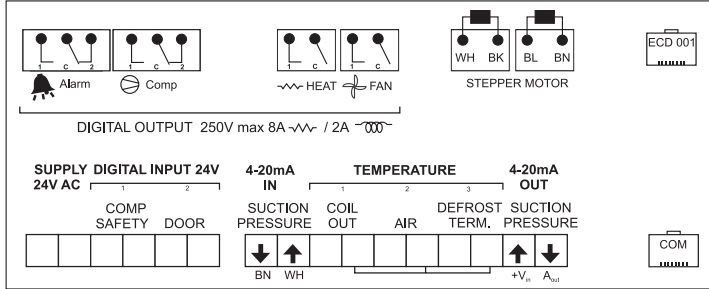

EC3 analog inputs are for dedicated sensors only and should not be connected to any other devices. Digital inputs should only be connected to 24VAC/DC. Connecting any EC3 inputs to mains voltage will permanently damage the EC3.

Important: Keep controller and sensor wiring well separated from mains wiring. Minimum recommended distance 30mm..

Warning: Use a class II category transformer for 24VAC power supply (EN 60742). Do not ground the 24VAC lines. We recommend to use one transformer per EC3 controller and to use separate transformers for 3rd party controllers, to avoid possible interference or grounding problems in the power supply. Connecting any EC3 inputs to mains voltage will permanently damage the EC3.

Recommended Sensor Positions for Cold Room Applications:

ECN-Pxx coil-out temperature sensor (1): Position directly after the evaporator on the common suction line as shown below. Insure proper thermal contact by using a metallic pipe clamp or temperature resistant plastic straps. Do not use standard plastic tie wraps (as used for electrical wiring) as they may become loose over time, which could result in faulty temperature measurements and poor superheat control performance. It is recommended to insulate the coil-out temperature sensor with ARMAFLEX™ or equivalent. The recommended position of the pipe sensors is between 9 and 3 o'clock as shown in the picture.

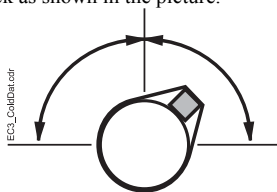

PT4-07S suction pressure transmitter (4): Position on the common suction line close to coil-out temperature sensor (1)

ECN-Sxx air temperature sensor (2): Should be mounted on spacers in the middle of the air duct so that there is airflow around and positioned on the inlet of the evaporator as high as possible close to the ceiling.

ECN-Fxx fin temperature sensor (3): Position on the evaporator, asymmetric closer to the expansion valve.

Setup and Parameter Modification Using the Keypad of the ECD-001

For convenience, an infrared receiver for the optional **IR remote control unit** is build-in, enabling quick and easy modification of the system parameters when a computer interface is not available.

Alternatively, the parameters can be accessed via the 4-button keypad. The configuration parameters are protected by a numerical password. The default password is "12". To select the parameter configuration:

Press the **PRG** button for more than 5 seconds

A flashing 0 is displayed

Press **▲** or **▼** until 12 is displayed; (password)

Press **SEL** to confirm password

The first modifiable parameter code is displayed (/1).

To modify parameters see Parameters modification below.

Parameter Modification: Procedure

Press **▲** or **▼** to show the code of the parameter that has to be changed;

Press **SEL** to display the selected parameter value;

Press **▲** or **▼** to increase or decrease the value;

Press **SEL** to temporarily confirm the new value and display its code;

Repeat the procedure from the beginning "press **▲** or **▼** to show..."

To exit and save the new settings:

Press **PRG** to confirm the new values and exit the parameters modification procedure.

To exit without modifying any parameter:

Do not press any button for at least 60 seconds (TIME OUT).

Press "ESC" on IR remote control.

Defrost Activation:

A defrost cycle can be activated locally from the keypad :

Press the **▼** button for more than 5 seconds

A flashing 0 is displayed

Press **▲** or **▼** until 12 is displayed; (password)

Press **SEL** to confirm password

The defrost cycle is activated

Special Functions:

The Clear Alarm function has been replaced by the Special Functions mode. The Special Functions can be activated by:

Press **▲** and **▼** together for more than 5 seconds.

A flashing 0 is displayed.

Press **▲** or **▼** until the password is displayed (default = 12). If password was changed, select the new password.

Press **SEL** to confirm password

A 0 is displayed and the Special Function mode is activated.

Press **▲** or **▼** to select the function. The number of special functions is dynamic and controller dependent. See list below.

Press **SEL** to activate the function without leaving the special function mode.

Press **PRG** to activate the function and leave the special function mode.

Most of the Special Functions work in a toggle mode, the first call activates the function, and the second call deactivates the function.

The indication of the function can only be displayed after exiting the special function mode.

- 0: Display test function
- 1 :Clear alarm messages
- 2: Cleaning mode. The cleaning mode is effectively a manual defrost with the option of the fans on/off. The cleaning mode should not be used in order to isolate the application for maintenance purposes.
- 3: Fans only
- 4: Set the electronic control valve to 100% open
- 5: Displays the current TCP/IP address
- 6: Set the controller's TCP/IP address to 192.168.1.101 (default value). This change is only temporary. A power down will reset the previous address.
- 7: Resets all parameters to the factory default setting. The controller will indicate "oF" during the reset and the valve will close.

Display of Data:

The data to be permanently shown on the display can be selected by the user (parameter /1). In case of an alarm, the alarm code is displayed alternately with the selected data. The user can inhibit the alarm code.

It is possible to temporarily display these values. This is a useful feature when initially setting-up the system without the aid of the WebPages. Press the **SEL** button to scroll through all possible displayable data.. The display will show for one second the numerical identifier of the data (see /1 parameter) and then the selected data. After two minutes the display will return to the by parameter /1 selected data. This action is only valid when parameter H2 = 3

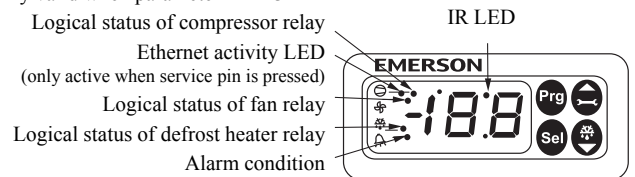

List Of Parameters

/ DISPLAY PARAMETERS		Min	Max	Unit	Def.	Custom
/1	Value to show 0 = Thermostat control temperature with Temp. alignment /C 1 = Defrost termination temperature °C 2 = Coil-in temperature °C calculated from the pressure 3 = Coil-out temperature °C 4 = Calculated superheat °K 5 = Valve opening in % 6 = Displays defrost status	0	6	-	0	
/2	Alarm suppression (0= off,1= on)	0	1	n/a	0	
/5	Temperature Unit (0 = °C, 1 = °F)	0	1		0	
/6	Decimal point (0 = yes, 1 = no)	0	1		0	
/7	ECD display during defrost 0 = dF (= defrost mode); 1 = dF + defrost termination temp. 2 = dF + control temperature	0	2		0	
/C	Temperature alignment for /1=0	- 20	+ 20	K / °F	0.0	

A ALARM-PARAMETERS

A1	Low temp alarm delay	0	180	min	5	
A2	High temp alarm delay	0	180	min	5	
A3	Alarm delay after defrost	0	180	min	10	
Ad	Door alarm delay	0	180	min	2	
AH	High temp alarm limit	AL	70	°C / K	40	
AL	Low temp alarm limit	-55	AH	°C / K	-50	
At	Alarm limit type 0=absolute temperatures °C; 1= relative temperatures K to setpoint	0	1	n/a	0	

r THERMOSTAT-PARAMETERS

r0	Door contact function (see page 4)	0	15	n/a	6	
r1	Min setpoint	- 50	r2	°C	- 50	
r2	Setpoint max	r1	+ 60	°C	40	
r3	Day/night control (0=off, 1=on)	0	1	n/a	1	
r4	Thermostat mode 0 = off, no thermostat function, continues cooling air in sensor monitoring off, no temp. alarms generated 1 = cooling, deadband control cut in = set-point + difference cut out = set-point 2 = cooling, modulating thermostat cut in = set-point cut out = set-point – difference /2 3 = heating, deadband control cut in = set-point – difference cut out = set-point 4 = on, external control using nvi Valve via SNMP. Air sensor monitoring off. Temperature alarms will be generated	0	4	-	1	
r6	Setpoint night	r1	r2	°C	4.0	
r7	Differential night	0.1	20.0	K	2.0	
rd	Differential day	0.1	+20.0	K	2.0	
St	Setpoint day	r1	r2	°C	2.0	

d DEFROST PARAMETERS

d0	Defrost mode 0 = natural defrost, defrost heater not activated pulsed defrost not possible 1 = forced defrost, defrost heater activated, pulsed defrost possible 2 = forced defrost, defrost heater activated, pulsed defrost possible, defrost termination using nviStartUp via SNMP	0	2	-	1	
d1	Termination by: 0 = termination by temperature, termination by time will generate an alarm 1 = termination by time, termination by temperature will generate an alarm 2 = first, what ever comes first time or temperature, no alarm 3 = last, by time and temperature, no alarm	0	3	-	0	
d3	Pulsed defrost 0 = off, no pulsed defrost, heaters switched off at defrost termination temperature dt or max. time dP whatever is selected on, pulsed defrost, dd and dH in use, heaters are switched off at dH and switched on again at dH – dd	0	1	n/a	0	
d4	Defrost at startup (0=no,1=yes)	0	1	n/a	0	
d5	Delay power up defrost	0	180	min	0	

		Min	Max	Unit	Def.	Custom
d6	Pump down delay Compressor will run during pump down delay while valve is closed	0	180	Sec	0	
d7	Drain delay	0	15	Min	2	
d8	Injection delay Valve is open during injection delay while compressor is not running	0	180	Sec	0	
dd	Pulsed defrost differential	1	20	K	2	
dH	Pulsed defrost setpoint	-40	dt	°C	5	
dt	Defrost termination temperature	- 40	+ 90	°C	8	
dP	Max defrost duration	0	180	Min	30	
dI	Defrost interval	0	192	Hr	8	
du	Start up delay after synch	0	180	Min	30	

F FAN-PARAMETERS

F1	Fan startup by: 0 = on 1 = delayed by time Fd, error on temperature 2 = by temperature Ft, error on time 3 = first, whatever comes first time or temperature, no alarm 4 = last, time and temperature must come, no alarm	0	4	-	0	
F2	During no cooling (0 = on; 1 = off, 2 = delayed by F4	0	2	-	0	
F3	During defrost (0=on,1=off)	0	1	n/a	0	
F4	Stop delay time	0	30	Min	0	
F5	During cleaning (0=off,1=on)	0	1	n/a	0	
Fd	Fan delay after defrost	0	30	Min	0	
Ft	On temp after defrost	- 40	+ 40	°C	0	

C COMPRESSOR-PARAMETERS

C0	Delay first start after power up	0	15	Min	0	
C1	Cycle time	0	15	Min	0	
C2	Min stop time it	0	15	Min	0	
C3	Min run time	0	15	Min	0	

u SUPERHEAT PARAMETERS

u0	Refrigerant (0 = R22, 1 = R134a, 2 = R507; 3 = R404A; 4 = R407C)	0	4	-	3	
u1	Correction glide / dp Glide = positive values Pressure drop = negative values	-20.0	20.0	K	0.0	
u2	MOP control (0= MOP off, 1= MOP on)	0	1	n/a	0	
u3	MOP temperature	- 40	+ 40	°C	0	
u4	Superheat mode (0 = off 1 = fixed superheat 2 = adaptive superheat)	0	2	-	1	
u5	Superheat init setpoint	u6	u7	K	6	
u6	Superheat setpoint min	3	u7	K	3	
u7	Superheat setpoint max	u6	20	K	15	
uu	Start opening	25	75	%	30	
ut	Valve type 0 = EX5, 1 = EX6, 2 = EX7, 3 = EX8	0	3	-	0	

P ANALOG SENSOR PARAMETERS

P1	Pressure sensor type selection 0 = PT4-07S; 1 = PT4-18S; 2 = PT4-30S	0	2	n/a	0	
----	---	---	---	-----	---	--

I LOGIC PARAMETERS

I0	Logic for comp. safety loop input 0 = 24V input voltg. means failure; 1 = 0V input voltg. means failure	0	1	n/a	0	
I1	Logic for door contact input 0 = 24V means door open; 1 = 0V means door open	0	1	n/a	0	
o0	Logic for alarm relays activated 0 = positive logic; 1 = negative logic	0	1	n/a	0	
o1	Logic for compressor relays activated 0 = positive logic; 1 = negative logic	0	1	n/a	0	
o2	Logic for heater relays activated 0 = positive logic; 1 = negative logic	0	1	n/a	0	
o3	Logic for fan relays activated 0 = positive logic; 1 = negative logic	0	1	n/a	0	

H OTHER PARAMETERS

H2	Display access 0 = all disabled (Caution, access to controller only via the TCP/IP network possible); 1 = Keyboard enabled; 2 = IR remote control enabled; 3 = Keyboard and IR rem. contr. en	0	3	-	3	
H3	IR access code	0	199	-	0	
H5	Password	0	199	-	12	

Remarks: r0 Door contact function.

r0	Cooling	Temp.Alarm	Function after delay time Ad
0 = 8	on	on	
1 = 9	off	on	
2 = 10	on	off	
3 = 11	off	off	
4 = 12	on	on	door alarm
5	off	on	door alarm
6 = 14	on	off	door alarm and temperature alarm on
7	off	off	door alarm and temperature alarm on
13	off	on	door alarm and cooling on
15	off	off	door alarm and cooling on and temperature alarm on

Alarm Codes

- E0 Pressure transmitter alarm**
- E1 Coil out sensor alarm**
- E2 Air sensor alarm**
- E3 Fin sensor alarm**
No sensor connected or the sensor and/or the sensor cable is broken or short-circuited.
- Er Data error display - out of range**
Data sent to the display is out of range.
- Ab Battery health failure**
Battery potentially does not have enough charge to close valve in an emergency. Only reset by replacing battery (Replacement kit: 807 790).
- AC Alarm status of the compressor serial loop feedback**
External compressor is active. Serial safety loop is open circuit
- Ad Door open alarm**
- AE Thermostat emergency operation**
Air sensor failure, system is in continuous cooling mode
- AF Valve Status**
Valve closed due to compressor safety loop active
- AH High temperature alarm**
- AL Low temperature alarm**
- AM ECV connection error**
Check connections to EX5...8 Electrical Control Valve
- Ao Superheat, emergency operation**
Sensor(s) failure
- Au Valve open 100% for more than 10 minutes**
- dt Forced defrost termination (time or temperature)**
- Ft Forced fan startup (time or temperature)**

Messages

- **No data to display**
The display will show an "---" at node start up and when no data is sent to the display.
- In** **Reset to default values activated**
The display will show an "In" when the factory default configuration data set is initialized.
- Id** **Wink request received**
The display will show a flashing "Id" when the wink request was received. The flashing "Id" will be shown on the display until the service button will be pressed, or a 30 min delay timer will expire or a second wink request is received. This function is action only when using SNMP protocol
- OF** **Node is offline**
The node is offline and no application is running. This is the result of a network management command and will happen for example during node installation.
- dS** **Defrost standby**
- dP** **Pump down**
- df** **Defrost cycle**
- dd** **Defrost drain delay**
- dl** **Defrost injection delay**
- du** **Defrost start-up delay**
- Cn** **Cleaning**
- CL** **Alarms are cleared**

Emerson Electric GmbH & Co OHG is not to be held responsible for erroneous literature regarding capacities, dimensions, applications, etc. stated herein. Products, specifications and data in this literature are subject to change without notice. The information given herein is based on technical data and tests which ALCO CONTROLS believes to be reliable and which are in compliance with

Visualising Data : WebPages

A TCP/IP Controller-Readme file is available on the www.eCopeland.com website to provide detailed information about TCP/IP Ethernet connectivity. Please refer to this file if you need information beyond the contents of this instruction sheet.

The EC3-332 has a TCP/IP Ethernet communication interface enabling the controller to be directly connected to a PC or network via the standard Ethernet port. The EC3-332 controller has embedded WebPages to enable the user to easily visualise the parameter lists using real text labels.

No special software or hardware is required.

Connect the EC3-332 using the optional ECX-N60 cable assembly to a network or hub that enables the controller to receive a dynamic TCP/IP address. If a DHCP server is not available, the controller can be connected to a computer using a crossover cable plugged directly into the Ethernet port. In this case, the TCP/IP address of the computer must be manually modified to be compatible with the default address of the controller. Refer to the TCP/IP Controller-Readme file for more details.

Open the Internet browser program on the computer and enter the default TCP/IP address of the controller into the address line of the Internet browser: **192.168.1.101** or the dynamic address from the DHCP server. Refer to the TCP/IP Controller-Readme file if a specific port is required.

After a few moments, the default monitoring page should be displayed. If the browser does not open the default page or display active data, the user should check the Internet browser "Option" configuration. Refer to the TCP/IP Controller-Readme file.

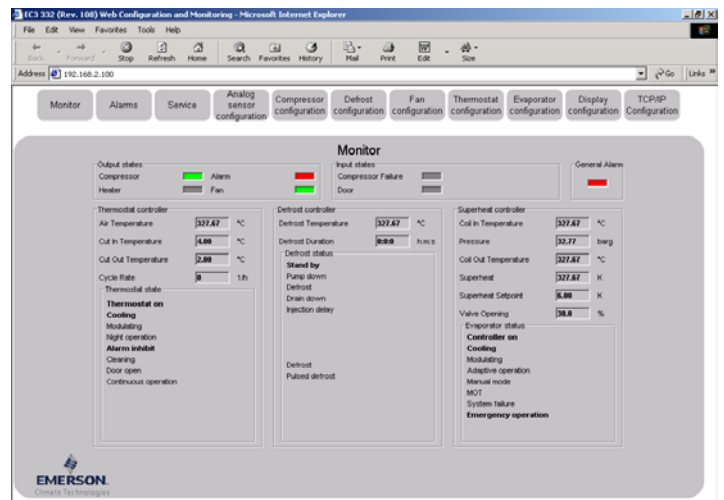

The Monitoring and Alarm WebPages are read only and therefore it is not necessary to enter a username or password. A username and password will be requested upon the initial request to any of the other WebPages. The factory default settings are :

Username : EmersonID Password : 12

The default settings may be modified in the Display configuration page. Press the tabs at the top of the Monitoring page with a left click of the mouse button to enter the respective Webpage.

The parameters will be visualised in real text together with the program code as defined in the parameter list below.

After the parameters have been modified, the complete list of settings can be saved to the memory of the computer and used later to upload into another controller. This can save a considerable amount of time when using multiple controllers and over a period of time, a library can be created containing the parameter lists for equipment for different applications.

It is also possible to display live graphical data from the controller. In addition, a permanent 30 days log file containing the control temperature at 15 minutes intervals is stored in the non-volatile memory to be later transferred using FTP to the computer. The log file can be imported into a standard spreadsheet program such as Excel. Refer to the TCP/IP Controller-Readme file for a complete description of the features available for the TCP/IP series of controllers.

technical knowledge of today. It is intended only for use by persons having the appropriate technical knowledge and skills, at their own discretion and risk. Since conditions of use are outside of ALCO'S control we cannot assume any liability for results obtained or damages occurred due to improper application.

This document replaces all former versions