

Chiller-HP Modular pLAN for 1/8 compressors

Manual version: 4.112 – 13/02/2002

Program code: **EPSTDEMCHA**



We wish to save you time and money!

We can assure you that the thorough reading of this manual will guarantee correct installation and safe use of the product described.

IMPORTANT WARNINGS



BEFORE INSTALLING OR OPERATING ON THE DEVICE, CAREFULLY READ THE INSTRUCTIONS IN THIS MANUAL.

The instrument for which this software is dedicated has been designed to operate without risks for the established purposes, provided that:

- the conditions described in the installation and operating manual for the device in question are observed
- the installation of the software, operation and maintenance are performed according to the instructions provided in this manual, by qualified personnel.

Any different use or changes that have not been previously authorised by the manufacturer, are considered improper. Liability for injuries or damage caused by improper use lies exclusively with the user.

Contents:

1.	APPLICATIONS AND FUNCTIONS PERFORMED BY THE SYSTEM.....	3
1.1	TYPE OF UNITS CONTROLLED	3
1.2	TYPE OF CONTROL.....	3
1.3	TYPE OF COMPRESSORS	3
1.4	MAXIMUM NUMBER OF COMPRESSORS.....	3
1.5	ROTATION OF COMPRESSOR CALLS	3
1.6	CONDENSER CONTROL	3
1.7	TYPE OF DEFROST.....	3
1.8	SAFETY DEVICES ON EACH REFRIGERANT CIRCUIT	3
1.9	SYSTEM SAFETY DEVICES	3
1.10	ACCESSORIES	3
2.	STRUCTURE OF THE MASTER/SLAVE SYSTEM	4
2.1	FUNCTIONS OF THE MASTER	4
2.2	FUNCTIONS OF THE SLAVES	4
2.3	CONTROL PROBE	4
2.4	SETTING THE SYSTEM ADDRESS.....	4
3.	LIST OF INPUTS/OUTPUTS	5
3.1	AIR/WATER UNITS WITH MAXIMUM 8 TANDEM HERMETIC COMPRESSORS	5
3.2	AIR/AIR UNITS WITH MAXIMUM 8 TANDEM HERMETIC COMPRESSORS (CONDENSING)	7
3.3	WATER/WATER UNITS WITH MAXIMUM 8 TANDEM HERMETIC COMPRESSORS.....	8
3.4	AIR/WATER UNITS WITH MAXIMUM 8 SEMI-HERMETIC COMPRESSORS (1 CAP. STAGE PER COMPRESSOR)	9
3.5	AIR/AIR UNITS WITH MAXIMUM 8 SEMI-HERMETIC COMPRESSORS (1 CAP. STAGE PER COMPRESSOR).....	11
3.6	WATER/WATER UNITS WITH MAXIMUM 8 SEMI-HERMETIC COMPRESSORS (1 CAP. STAGE PER COMPRESSOR)	12
3.7	AIR/WATER UNITS WITH MAXIMUM 4 SEMI-HERMETIC COMPRESSORS (UP TO 3 CAP. STAGES PER COMP.).....	13
3.8	AIR/AIR UNITS WITH MAXIMUM 4 SEMI-HERMETIC COMPRESSORS (UP TO 3 CAP. STAGES PER COMP.).....	15
3.9	WATER/WATER UNITS WITH MAXIMUM 4 SEMI-HERMETIC COMPRESSORS (UP TO 3 CAP. STAGES PER COMP.)	16
4.	CONTROL	17
4.1	INLET TEMPERATURE CONTROL.....	17
4.2	OUTLET TEMPERATURE CONTROL	17
4.3	COMPRESSOR ROTATION	18
4.4	CONDENSER CONTROL	19
4.4.1	<i>On/off condenser control linked to compressor operation:.....</i>	<i>19</i>
4.4.2	<i>On/off condenser control linked to the pressure or temperature sensor:.....</i>	<i>19</i>
4.4.3	<i>Modulating condenser control linked to the pressure or temperature sensor:</i>	<i>19</i>
4.4.4	<i>Prevent function:.....</i>	<i>20</i>
4.5	DEFROST CONTROL FOR WATER/AIR MACHINES	21
4.5.1	<i>Type of defrost 1: simultaneous global / simultaneous local</i>	<i>21</i>
4.5.2	<i>Type of defrost 2: separate global / simultaneous local.....</i>	<i>21</i>
4.5.3	<i>Type of defrost 3: separate global / separate local.....</i>	<i>21</i>
4.6	CONDENSING UNIT CONTROL	23
4.6.1	<i>Proportional control</i>	<i>23</i>
4.6.2	<i>Stepped control.....</i>	<i>23</i>
4.7	CONTROL OF WATER/WATER UNITS WITH REVERSAL ON THE WATER CIRCUIT.....	24
4.8	ANTIFREEZE CONTROL	24
4.9	RECOVERY CONTROL	25
4.9.1	<i>Recovery priority.....</i>	<i>25</i>
4.9.2	<i>Utility priority</i>	<i>25</i>
4.10	FREECOOLING CONTROL.....	26
4.10.1	<i>Operating description.....</i>	<i>26</i>
4.11	ACTIVATION OF THE FREECOOLING FUNCTION	27
4.12	FREECOOLING THERMOSTAT.....	27
4.13	ON/OFF FREECOOLING VALVE	28
4.14	ON/OFF FREECOOLING VALVE WITH STEPPED CONDENSER CONTROL.....	28
4.15	ON/OFF FREECOOLING VALVE WITH CONDENSER INVERTER	29
4.16	0-10 VOLT FREECOOLING VALVE	29
4.17	0-10 VOLT FREECOOLING VALVE WITH STEPPED CONDENSER CONTROL.....	29
4.18	0-10 VOLT FREECOOLING VALVE WITH CONDENSER INVERTER	30
5.	PUMP-DOWN.....	31

6.	ALARMS	32
6.1	GENERAL DESCRIPTION	32
6.1.1	<i>Signal-only alarms</i>	32
6.1.2	<i>Circuit alarms</i>	32
6.1.3	<i>Serious alarms</i>	32
6.1.4	<i>Serious alarms</i>	32
6.2	LOGGING THE ALARMS	32
6.3	TABLE OF ALARMS	33
7.	PLAN NETWORK	34
7.1	I/O BOARD ADDRESSES	34
7.2	TERMINAL ADDRESSES	35
7.3	TERMINAL MANAGEMENT	35
7.4	TERMINAL CONFIGURATION PROCEDURE	36
7.4.1	<i>Step 1: select the pCO board</i>	36
7.4.2	<i>Step 2: select associated terminals</i>	36
7.4.3	<i>Display terminal connection status</i>	37
7.4.4	<i>Display network status: NetSTAT</i>	37
8.	USER INTERFACE	38
8.1	TABLE OF PARAMETERS	38
8.2	TERMINAL KEYPAD-DISPLAY: FRONT VIEW	40
8.3	USING THE BUTTONS	40
8.4	LEDS	41
8.5	DISPLAY	41
8.5.1	<i>Moving inside the screens</i>	41
9.	SUPERVISOR	42
10.	LIST OF SCREENS	44
10.1.1	<i>Menu button</i>	44
10.1.2	<i>Set button</i>	44
10.1.3	<i>I/O button</i>	44
10.1.4	<i>Menu+Prog button</i>	44
10.1.5	<i>Prog button</i>	44
10.1.6	<i>Maintenance button</i>	45
10.1.7	<i>Printer button</i>	45
10.1.8	<i>Clock button</i>	45
10.1.9	<i>Alarm button</i>	45

1. Applications and functions performed by the system

1.1 Type of units controlled

Cooling only condensing unit
Condensing unit with heat pump
Air / water chiller only
Air / water chiller + freecooling
Air / water total recovery
Air / water chiller + heat pump
Air / water chiller only
Air / water chiller + heat pump (water reversal)

1.2 Type of control

Proportional or proportional + integral control on the evaporator inlet probe.
Dead zone control on the evaporator outlet probe (compressor insertion according to a band and a time)

1.3 Type of compressors

Tandem hermetic compressors
Semi-hermetic compressors with 1 capacity stage
Semi-hermetic compressors with 3 capacity stages

1.4 Maximum number of compressors

From 1 to 4 with max. 3 capacity compressor stages (1 compressor for each pCO I/O board)
From 1 to 8 with max. 1 capacity compressor stage (2 compressors for each pCO I/O board)
From 4 to 8 with no capacity control (tandem compressors) (4 compressors for each pCO I/O board)

1.5 Rotation of compressor calls

Rotation of each compressor with FIFO logic

1.6 Condenser control

Condenser control according to temperature or pressure
Fans can be managed in ON/OFF mode or by a 0/10V modulating signal

1.7 Type of defrost

Global defrosting of all the pCO units connected to the network: independent/simultaneous/separate.
Local defrosting of the individual pCO unit: separate/simultaneous

1.8 Safety devices on each refrigerant circuit

High pressure (pressure switch)
Low pressure (pressure switch)
Differential oil pressure switch
Compressor thermal overload
Condenser fan thermal overload

1.9 System safety devices

Serious alarm input (stops the whole unit)
One flow-controller input (stops the whole unit), available on both MASTER and SLAVE units from version 2.012
One pump thermal overload input (stops the whole unit), available on both MASTER and SLAVE units from version 2.012
Remote on/off input without alarm signal

1.10 Accessories

Supervision with RS422/RS485 serial card
On/off time bands with clock card.
Alarm log with clock card.

2. Structure of the master/slave system

2.1 Functions of the master

Temperature control
 Calling of all compressors
 Management of system alarms
 Management of max. 2 refrigerant circuits (start, stop, alarms) for each board
 Possibility to communicate with an external supervisor

2.2 Functions of the slaves

Management of max. 2 refrigerant circuits (start, stop, alarms)

2.3 Control probe

The temperature control probe must be connected to the master pCO only.

2.4 Setting the system address

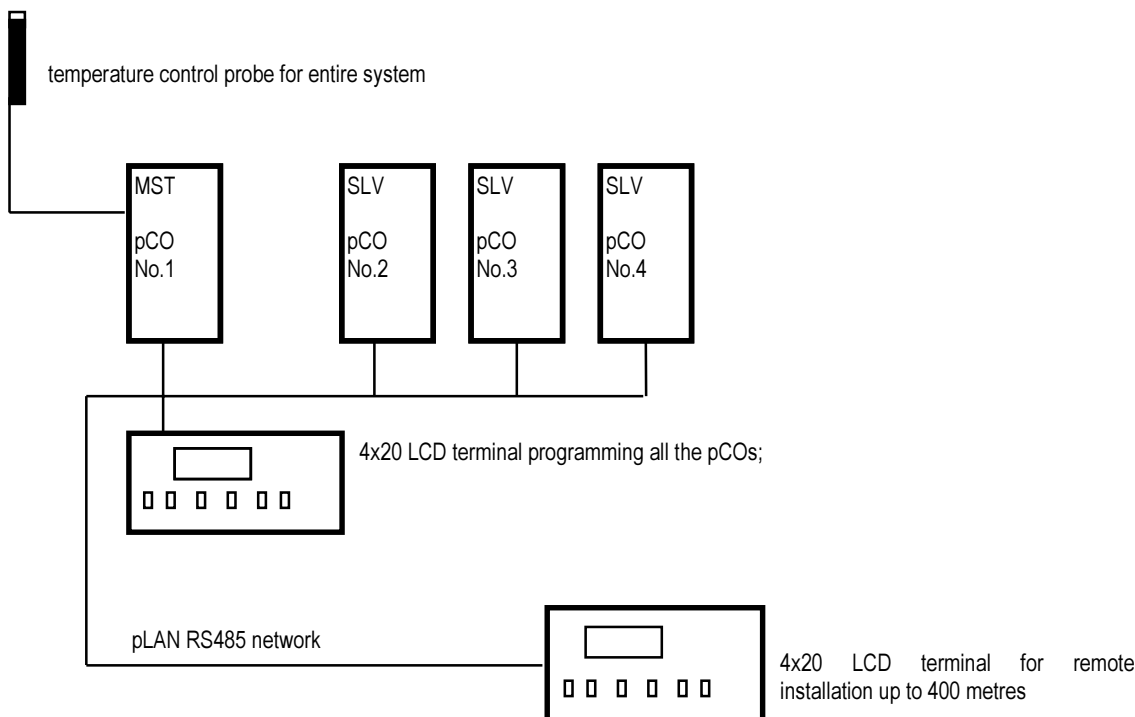

Every master pCO, pCO slave board and each terminal are identified by an address. The address of the terminals is selected using the dipswitches at the rear of the terminals, whereas the address of the I/O boards is selected using the dipswitches on card code PCOADR0000 (without clock option) or PCOCLKMEM0 (with clock option); this card must be inserted into the clock PLUG-IN connector.

The address of the master pCO must be 1

The address of slave pCO 1 must be 2

The address of slave pCO 2 must be 3

The address of slave pCO 3 must be 4

The address of the local terminal must be 5

The address of the remote terminal may be from 6 to 16

Note: When the machine is switched ON, all I/O boards MUST be switched ON (the On/Off LED on the pCO terminal must be ON for all units)

- The master unit switches the whole machine ON/OFF
- Each slave unit switches itself ON/OFF only. If a slave unit is OFF and the master is ON, the slave will be switched ON. If a slave unit is ON and the master is OFF, the slave won't be switched ON.

3. List of inputs/outputs

Following is a list of the inputs and outputs for each the type of unit; each machine type has been given a number. This number is the main parameter of the program, in that it identifies the configuration of the inputs and outputs. In this way, the configuration of the machine is greatly simplified, performed by simply choosing the list of inputs and outputs required and selecting the associated number in the configuration screens of the program. Each of the following pages contains 2 types of unit, and for each unit the inputs and outputs are described for the pCO master and one of the pCO slaves.

3.1 AIR/WATER units with maximum 8 tandem hermetic compressors

Digital inputs

Chiller-only unit MACHINE TYPE "0"			Chiller unit with freecooling MACHINE TYPE "1"	
No.	Master	Slave no.1	Master	Slave no.1
1	Serious alarm	Serious alarm (can be enabled)	Serious alarm	Serious alarm (can be enabled)
2	Evaporator flow switch	Evaporator flow switch (enable)	Evaporator flow switch	Evaporator flow switch (enable)
3	Remote ON/OFF		Remote ON/OFF	
4	Pump thermal overload		Pump thermal overload	
5	Low pressure switch 1	Low pressure switch 3	Low pressure switch 1	Low pressure switch 3
6	Comp. 1 thermal overload	Thermal overload Comp. 5	Comp. 1 thermal overload	Thermal overload Comp. 5
7	Comp. 2 thermal overload	Thermal overload Comp. 6	Comp. 2 thermal overload	Thermal overload Comp. 6
8	Low pressure switch 2	Low pressure switch 4	Low pressure switch 2	Low pressure switch 4
9	Comp. 3 thermal overload	Thermal overload Comp. 7	Comp. 3 thermal overload	Thermal overload Comp. 7
10	Comp. 4 thermal overload	Thermal overload Comp. 8	Comp. 4 thermal overload	Thermal overload Comp. 8
11	High pressure switch 1	High pressure switch 3	High pressure switch 1	High pressure switch 3
12	High pressure switch 2	High pressure switch 4	High pressure switch 2	High pressure switch 4

Analogue inputs

Chiller-only unit			Chiller unit with freecooling	
no.	Master	Slave no.1	Master	Slave no.1
1	Water inlet temp.		Water inlet temp.	
2	Water outlet temp. 1	Water outlet temp. 2	Water outlet temp. 1	Water outlet temp. 2
3	Condensing temp. Circuit 1	Condensing temp. Circuit 3	Condensing temp. Circuit 1	Condensing temp. Circuit 3
4	Condensing temp. Circuit 2	Condensing temp. Circuit 4	Condensing temp. Circuit 2	Condensing temp. Circuit 4
5	Outside set point		Outside temperature	
6			Freecooling temperature	
7	High pressure transducers circuit 1	High pressure transducers circuit 3	High pressure transducers circuit 1	High pressure transducers circuit 3
8	High pressure transducers circuit 2	High pressure transducers circuit 4	High pressure transducers circuit 2	High pressure transducers circuit 4

Digital outputs

Chiller-only unit			Chiller unit with freecooling	
no.	Master	Slave no.1	Master	Slave no.1
1	Pump		Pump	
2	Compressor 1	Compressor 5	Compressor 1	Compressor 5
3	Compressor 2	Compressor 6	Compressor 2	Compressor 6
4	Liquid solenoid circuit 1	Liquid solenoid circuit 3	Liquid solenoid circuit 1	Liquid solenoid circuit 3
5				
6	Compressor 3	Compressor 7	Compressor 3	Compressor 7
7	Compressor 4	Compressor 8	Compressor 4	Compressor 8
8	Liquid solenoid circuit 2	Liquid solenoid circuit 4	Liquid solenoid circuit 2	Liquid solenoid circuit 4
9			Condenser fans Circuit 2	Condenser fans Circuit 4
10	Antifreeze heater 1	Antifreeze heater 2	Antifreeze heater 1	Antifreeze heater 2
11	Cumulative fault alarms	Cumulative fault alarms	Cumulative fault alarms	Cumulative fault alarms
12	Condenser fans Circuit 1	Condenser fans Circuit 3	Condenser fans Circuit 1	Condenser fans Circuit 3
13	Condenser fans Circuit 2	Condenser fans Circuit 4	On/off freecooling valve	

Analogue outputs

Chiller-only unit			Chiller unit with freecooling	
no.	Master	Slave no.1	Master	Slave no.1
1	Condenser fan 1 speed cont.	Condenser fan 3 speed cont.	Condenser fan 1 speed cont.	Condenser fan 3 speed cont.
2	Condenser fan 2 speed cont.	Condenser fan 4 speed cont.	Modul. freecooling valve	

Digital inputs

Chiller unit with Heat pump MACHINE TYPE "2"			Chiller unit with heat p. and complete recovery MACHINE TYPE "3"	
no.	Master	Slave no.1	Master	Slave no.1
1	Serious alarm	Serious alarm (can be enabled)	Serious alarm	Serious alarm (can be enabled)
2	Evaporator flow switch	Evaporator flow switch (enable)	Evaporator flow switch	Evaporator flow switch (enable)
3	Remote ON/OFF		Remote ON/OFF	
4	Cooling/heating switch		Cooling/heating switch	
5	Low pressure switch 1	Low pressure switch 3	Low pressure switch 1	Low pressure switch 3
6	Comp. 1 thermal overload	Thermal overload Comp. 5	Comp. 1 thermal overload	Thermal overload Comp. 5
7	Comp. 2 thermal overload	Thermal overload Comp. 6	Comp. 2 thermal overload	Thermal overload Comp. 6
8	Low pressure switch 2	Low pressure switch 4	Low pressure switch 2	Low pressure switch 4
9	Comp. 3 thermal overload	Thermal overload Comp. 7	Comp. 3 thermal overload	Thermal overload Comp. 7
10	Comp. 4 thermal overload	Thermal overload Comp. 8	Comp. 4 thermal overload	Thermal overload Comp. 8
11	High pressure switch 1	High pressure switch 3	High pressure switch 1	High pressure switch 3
12	High pressure switch 2	High pressure switch 4	High pressure switch 2	High pressure switch 4

Analogue inputs

Chiller unit with Heat pump			Chillers with Heat Pump with complete recovery	
no	Master	Slave no.1	Master	Slave no.1
1	Water inlet temp.		Water inlet temp.	
2	Water outlet temp. 1	Water outlet temp. 2	Water outlet temp. 1	Water outlet temp. 2
3	Condensing temp. Circuit 1	Condensing temp. Circuit 3	Condensing temp. Circuit 1	Condensing temp. Circuit 3
4	Condensing temp. Circuit 2	Condensing temp. Circuit 4	Condensing temp. Circuit 2	Condensing temp. Circuit 4
5	Outside set point		Recovery inlet temp.	
6			Recovery outlet temp.	
7	High pressure transducers circuit 1	High pressure transducers circuit 3	High pressure transducers circuit 1	High pressure transducers circuit 3
8	High pressure transducers circuit 2	High pressure transducers circuit 4	High pressure transducers circuit 2	High pressure transducers circuit 4

Digital outputs

Chiller unit with Heat pump			Chillers with Heat Pump with complete recovery	
no	Master	Slave no.1	Master	Slave no.1
1	Pump		Pump	
2	Compressor 1	Compressor 5	Compressor 1	Compressor 5
3	Compressor 2	Compressor 6	Compressor 2	Compressor 6
4	Liquid solenoid circuit 1	Liquid solenoid circuit 3	Liquid solenoid circuit 1	Liquid solenoid circuit 3
5	4-way valve circuit 1	4-way valve circuit 3	Valve A	
6	Compressor 3	Compressor 7	Compressor 3	Compressor 7
7	Compressor 4	Compressor 8	Compressor 4	Compressor 8
8	Liquid solenoid circuit 2	Liquid solenoid circuit 4	Liquid solenoid circuit 2	Liquid solenoid circuit 4
9	4-way valve circuit 2	4-way valve circuit 4	Valve B	
10	Antifreeze heater 1	Antifreeze heater 2	Antifreeze heater 1	Antifreeze heater 2
11	Cumulative fault alarms	Cumulative fault alarms	Cumulative fault alarms	Cumulative fault alarms
12	Condenser fans Circuit 1	Condenser fans Circuit 3	Condenser fans	Condenser fans
13	Condenser fans Circuit 2	Condenser fans Circuit 4	Valve C	

Analogue outputs

Chiller unit with Heat pump			Chillers with Heat Pump with complete recovery	
no	Master	Slave no.1	Master	Slave no.1
1	Condenser fan 1 speed cont.	Condenser fan 3 speed cont.	Condenser fan speed cont.	Condenser fan speed cont.
2	Condenser fan 2 speed cont.	Condenser fan 4 speed cont.		

3.2 AIR/AIR units with maximum 8 tandem hermetic compressors (condensing)

Digital inputs

Condensing unit, cooling only MACHINE TYPE "4"			Condensing unit, with heat pump MACHINE TYPE "5"	
no	Master	Slave no.1	Master	Slave no.1
1	Serious alarm	Serious alarm (can be enabled)	Serious alarm	Serious alarm (can be enabled)
2	Evaporator flow switch	Evaporator flow switch (enable)	Evaporator flow switch	Evaporator flow switch (enable)
3	Remote ON/OFF		Remote ON/OFF	
4	Main fan thermal overload		Cooling/heating switch	
5	Low pressure switch 1	Low pressure switch 3	Low pressure switch 1	Low pressure switch 3
6	Comp. 1 thermal overload	Thermal overload Comp. 5	Comp. 1 thermal overload	Thermal overload Comp. 5
7	Comp. 2 thermal overload	Thermal overload Comp. 6	Comp. 2 thermal overload	Thermal overload Comp. 6
8	Low pressure switch 2	Low pressure switch 4	Low pressure switch 2	Low pressure switch 4
9	Comp. 3 thermal overload	Thermal overload Comp. 7	Comp. 3 thermal overload	Thermal overload Comp. 7
10	Comp. 4 thermal overload	Thermal overload Comp. 8	Comp. 4 thermal overload	Thermal overload Comp. 8
11	High press. switch 1 and Condenser fan 1 overload	High press. switch 3 and Condenser fan 3 overload	High press. switch 1 and Condenser fan 1 overload	High press. switch 3 and Condenser fan 3 overload
12	High press. switch 2 and Condenser fan 2 overload	High press. switch 4 and Condenser fan 4 overload	High press. switch 2 and Condenser fan 2 overload	High press. switch 4 and Condenser fan 4 overload

Analogue inputs

Condensing unit, cooling only MACHINE TYPE "4"			Condensing unit with heat pump	
no	Master	Slave no.1	Master	Slave no.1
1	Water inlet temp.		Water inlet temp.	
2	Water outlet temp. 1	Water outlet temp. 2	Water outlet temp. 1	Water outlet temp. 2
3	Condensing temp. Circuit 1	Condensing temp. Circuit 3	Condensing temp. Circuit 1	Condensing temp. Circuit 3
4	Condensing temp. Circuit 2	Condensing temp. Circuit 4	Condensing temp. Circuit 2	Condensing temp. Circuit 4
5	Remote compressor control		Remote compressor control	
6				
7	High pressure transducers circuit 1	High pressure transducers circuit 3	High pressure transducers circuit 1	High pressure transducers circuit 3
8	High pressure transducers circuit 2	High pressure transducers circuit 4	High pressure transducers circuit 2	High pressure transducers circuit 4

Digital outputs

Condensing unit, cooling only MACHINE TYPE "4"			Condensing unit with heat pump	
no	Master	Slave no.1	Master	Slave no.1
1	Fan circulation		Fan circulation	
2	Compressor 1	Compressor 5	Compressor 1	Compressor 5
3	Compressor 2	Compressor 6	Compressor 2	Compressor 6
4	Liquid solenoid circuit 1	Liquid solenoid circuit 3	Liquid solenoid circuit 1	Liquid solenoid circuit 3
5			4-way valve circuit 1	4-way valve circuit 3
6	Compressor 3	Compressor 7	Compressor 3	Compressor 7
7	Compressor 4	Compressor 8	Compressor 4	Compressor 8
8	Liquid solenoid circuit 2	Liquid solenoid circuit 4	Liquid solenoid circuit 2	Liquid solenoid circuit 4
9			4-way valve circuit 2	4-way valve circuit 4
10	Antifreeze heater 1	Antifreeze heater 2	Antifreeze heater 1	Antifreeze heater 2
11	Cumulative fault alarms	Cumulative fault alarms	Cumulative fault alarms	Cumulative fault alarms
12	Condenser fans Circuit 1	Condenser fans Circuit 3	Condenser fans Circuit 1	Condenser fans Circuit 3
13	Condenser fans Circuit 2	Condenser fans Circuit 4	Condenser fans Circuit 2	Condenser fans Circuit 4

Analogue outputs

Condensing unit, cooling only			Condensing unit with heat pump	
no	Master	Slave no.1	Master	Slave no.1
1	Condenser fan 1 speed cont.	Condenser fan 3 speed cont.	Condenser fan 1 speed cont.	Condenser fan 3 speed cont.
2	Condenser fan 2 speed cont.	Condenser fan 4 speed cont.	Condenser fan 2 speed cont.	Condenser fan 4 speed cont.

3.3 WATER/WATER units with maximum 8 tandem hermetic compressors.

Digital inputs

Chiller-only unit MACHINE TYPE "6"			Cooling/heating unit with water reversal MACHINE TYPE "7"	
no	Master	Slave no.1	Master	Slave no.1
1	Serious alarm	Serious alarm (can be enabled)	Serious alarm	Serious alarm (can be enabled)
2	Evaporator flow switch	Evaporator flow switch (enable)	Evaporator flow switch	Evaporator flow switch (enable)
3	Remote ON/OFF		Remote ON/OFF	
4	Pump thermal overload		Cooling/heating switch	
5	Low pressure switch 1	Low pressure switch 3	Low pressure switch 1	Low pressure switch 3
6	Comp. 1 thermal overload	Thermal overload Comp. 5	Comp. 1 thermal overload	Thermal overload Comp. 5
7	Comp. 2 thermal overload	Thermal overload Comp. 6	Comp. 2 thermal overload	Thermal overload Comp. 6
8	Low pressure switch 2	Low pressure switch 4	Low pressure switch 2	Low pressure switch 4
9	Comp. 3 thermal overload	Thermal overload Comp. 7	Comp. 3 thermal overload	Thermal overload Comp. 7
10	Comp. 4 thermal overload	Thermal overload Comp. 8	Comp. 4 thermal overload	Thermal overload Comp. 8
11	High pressure switch 1	High pressure switch 3	High pressure switch 1	High pressure switch 3
12	High pressure switch 2	High pressure switch 4	High pressure switch 2	High pressure switch 4

Analogue inputs

Chiller-only unit			Cooling/heating unit with water reversal	
no	Master	Slave no.1	Master	Slave no.1
1	Water inlet temp.		Water inlet temp.	
2	Water outlet temp. 1	Water outlet temp. 2	Water outlet temp. 1	Water outlet temp. 2
3	Condensing temp. Input 1	Condenser 2 water inlet temp.	Condensing temp. Input 1	Condenser 2 water inlet temp.
4	Condenser 1 water outlet temp.	Condenser 2 water outlet temp.	Condenser 1 water outlet temp.	Condenser 2 water outlet temp.
5	Outside set point		Outside set point	
6				
7	High pressure transducers circuit 1	High pressure transducers circuit 3	High pressure transducers circuit 1	High pressure transducers circuit 3
8	High pressure transducers circuit 2	High pressure transducers circuit 4	High pressure transducers circuit 2	High pressure transducers circuit 4

Digital outputs

Chiller-only unit			Cooling/heating unit with water reversal	
no	Master	Slave no.1	Master	Slave no.1
1	Pump		Pump	
2	Compressor 1	Compressor 5	Compressor 1	Compressor 5
3	Compressor 2	Compressor 6	Compressor 2	Compressor 6
4	Liquid solenoid circuit 1	Liquid solenoid circuit 3	Liquid solenoid circuit 1	Liquid solenoid circuit 3
5			Reversing valve water	
6	Compressor 3	Compressor 7	Compressor 3	Compressor 7
7	Compressor 4	Compressor 8	Compressor 4	Compressor 8
8	Liquid solenoid circuit 2	Liquid solenoid circuit 4	Liquid solenoid circuit 2	Liquid solenoid circuit 4
9	Condenser pump		Condenser pump	
10	Antifreeze heater 1	Antifreeze heater 2	Antifreeze heater 1	Antifreeze heater 2
11	Cumulative fault alarms	Cumulative fault alarms	Cumulative fault alarms	Cumulative fault alarms
12				
13				

Analogue outputs

Chiller-only unit			Cooling/heating unit with water reversal	
no	Master	Slave no.1	Master	Slave no.1
1				
2				

3.4 AIR/WATER units with maximum 8 semi-hermetic compressors (1 cap. stage per compressor)

Digital inputs

Chiller-only unit MACHINE TYPE "8"		Chiller unit with freecooling MACHINE TYPE "9"		
no	Master	Slave no.1-3	Master	Slave no.1-3
1	Serious alarm	Serious alarm (can be enabled)	Serious alarm	Serious alarm (can be enabled)
2	Evaporator flow switch	Evaporator flow switch (enable)	Evaporator flow switch	Evaporator flow switch (enable)
3	Remote ON/OFF		Remote ON/OFF	
4	Pump thermal overload		Pump thermal overload	
5	Low press. switch 1	Low press. switch 3	Low press. switch 1	Low press. switch 3
6	Oil differential 1	Oil differential 3	Oil differential 1	Oil differential 3
7	Fan 1 thermal overload	Fan 3 thermal overload	Fan 1 thermal overload	Fan 3 thermal overload
8	Low press. switch 2	Low press. switch 4	Low press. switch 2	Low press. switch 4
9	Oil differential 2	Oil differential 4	Oil differential 2	Oil differential 4
10	Fan 2 thermal overload	Fan 4 thermal overload	Fan 2 thermal overload	Fan 4 thermal overload
11	High press. switch. 1 / Comp. 1 thermal overload	High press. switch. 3 / Comp. 3 thermal overload	High press. switch. 1 / Comp. 1 thermal overload	High press. switch. 3 / Comp. 3 thermal overload
12	High press. switch. 2 / Comp. 2 thermal overload	High press. switch. 4 / Comp. 4 thermal overload	High press. switch. 2 / Comp. 2 thermal overload	High press. switch. 4 / Comp. 4 thermal overload

Analogue inputs

Chiller-only unit		Chiller unit with freecooling		
no	Master	Slave no.1-3	Master	Slave no.1-3
1	Water inlet temp.		Water inlet temp.	
2	Water outlet temp. 1	Water outlet temp. 2	Water outlet temp. 1	Water outlet temp. 2
3	Condensing temp. Circuit 1	Condensing temp. Circuit 3	Condensing temp. Circuit 1	Condensing temp. Circuit 3
4	Condensing temp. Circuit 2	Condensing temp. Circuit 4	Condensing temp. Circuit 2	Condensing temp. Circuit 4
5	Outside set point		Outside temperature	
6			Freecooling temperature	
7	High pressure transducers circuit 1	High pressure transducers circuit 3	High pressure transducers circuit 1	High pressure transducers circuit 3
8	High pressure transducers circuit 2	High pressure transducers circuit 4	High pressure transducers circuit 2	High pressure transducers circuit 4

Digital outputs

Chiller-only unit		Chiller unit with freecooling		
no	Master	Slave no.1-3	Master	Slave no.1-3
1	Pump		Pump	
2	Winding a comp.1	Winding a comp.3	Winding a comp.1	Winding a comp.3
3	Winding b comp.1	Winding b comp.3	Winding b comp.1	Winding b comp.3
4	Liquid solenoid circuit 1	Liquid solenoid circuit 3	Liquid solenoid circuit 1	Liquid solenoid circuit 3
5	Capacity-control comp.1	Capacity-control comp.3	Capacity-control comp.1	Capacity-control comp.3
6	Winding a comp.2	Winding a comp.4	Winding a comp.2	Winding a comp.4
7	Winding b comp.2	Winding b comp.4	Winding b comp.2	Winding b comp.4
8	Liquid solenoid circuit 2	Liquid solenoid circuit 4	Liquid solenoid circuit 2	Liquid solenoid circuit 4
9	Capacity-control comp.2	Capacity-control comp.4	Capacity-control comp.2	Capacity-control comp.4
10	Antifreeze heater 1	Antifreeze heater 2	Condenser fans Circuit 2	Antifreeze heater 2
11	Cumulative fault alarms	Cumulative fault alarms	Cumulative fault alarms	Cumulative fault alarms
12	Condenser fans Circuit 1	Condenser fans Circuit 3	Condenser fans Circuit 1	Condenser fans Circuit 3
13	Condenser fans Circuit 2	Condenser fans Circuit 4	Freecooling On/Off	Condenser fans Circuit 4

Analogue outputs

Chiller-only unit		Chiller unit with freecooling		
no	Master	Slave no.1-3	Master	Slave no.1-3
1	Condenser fan 1 speed cont.	Condenser fan 3 speed cont.	Condenser fan 1 speed cont.	Condenser fan 3 speed cont.
2	Condenser fan 2 speed cont.	Condenser fan 4 speed cont.	Modulating freecooling valve	Condenser fan 4 speed cont.

Digital inputs

		Chillers with Heat Pump MACHINE TYPE "10"		Chiller unit with P. heat a recovery tot. MACHINE TYPE "11"	
no	Master	Slave no.1-3	Master	Slave no.1-3	
1	Serious alarm	Serious alarm (can be enabled)	Serious alarm	Serious alarm (can be enabled)	
2	Evaporator flow switch	Evaporator flow switch (enable)	Evaporator flow switch	Evaporator flow switch (enable)	
3	Remote ON/OFF		Remote ON/OFF		
4	Cooling/heating switch		Cooling/heating switch		
5	Low press. switch 1	Low press. switch 3	Low press. switch 1	Low press. switch 3	
6	Oil differential 1	Oil differential 3	Oil differential 1	Oil differential 3	
7	Fan 1 thermal overload	Fan 3 thermal overload	Fan 1 thermal overload	Fan 3 thermal overload	
8	Low press. switch 2	Low press. switch 4	Low press. switch 2	Low press. switch 4	
9	Oil differential 2	Oil differential 4	Oil differential 2	Oil differential 4	
10	Fan 2 thermal overload	Fan 4 thermal overload	Fan 2 thermal overload	Fan 4 thermal overload	
11	High press. switch. 1 / Comp. 1 thermal overload	High press. switch. 3 / Comp. 3 thermal overload	High press. switch. 1 / Comp. 1 thermal overload	High press. switch. 3 / Comp. 3 thermal overload	
12	High press. switch. 2 / Comp. 2 thermal overload	High press. switch. 4 / Comp. 4 thermal overload	High press. switch. 2 / Comp. 2 thermal overload	High press. switch. 4 / Comp. 4 thermal overload	

Analogue inputs

		Chillers with Heat Pump		Chillers with Heat Pump and complete recovery	
no	Master	Slave no.1-3	Master	Slave no.1-3	
1	Water inlet temp.		Water inlet temp.		
2	Water outlet temp. 1	Water outlet temp. 2	Water outlet temp. 1	Water outlet temp. 2	
3	Condensing temp. Circuit 1	Condensing temp. Circuit 3	Condensing temp. Circuit 1	Condensing temp. Circuit 3	
4	Condensing temp. Circuit 2	Condensing temp. Circuit 4	Condensing temp. Circuit 2	Condensing temp. Circuit 4	
5	Outside set point		Recovery inlet temp.		
6			Recovery outlet temp.		
7	High pressure transducers circuit 1	High pressure transducers circuit 3	High pressure transducers circuit 1	High pressure transducers circuit 3	
8	High pressure transducers circuit 2	High pressure transducers circuit 4	High pressure transducers circuit 2	High pressure transducers circuit 4	

Digital outputs

		Chillers with Heat Pump		Chillers with Heat Pump and complete recovery	
no	Master	Slave no.1-3	Master	Slave no.1-3	
1	Pump		Pump		
2	Winding a comp.1	Winding a comp.3	Winding a comp.1	Winding a comp.3	
3	Winding b comp.1	Winding b comp.3	Winding b comp.1	Winding b comp.3	
4	4-way valve circuit 1	4-way valve circuit 3	Valve A		
5	Capacity-control comp.1	Capacity-control comp.3	Capacity-control comp.1	Capacity-control comp.3	
6	Winding a comp.2	Winding a comp.4	Winding a comp.2	Winding a comp.4	
7	Winding b comp.2	Winding b comp.4	Winding b comp.2	Winding b comp.4	
8	4-way valve circuit 2	4-way valve circuit 4	Valve B		
9	Capacity-control comp.2	Capacity-control comp.4	Capacity-control comp.2	Capacity-control comp.4	
10	Antifreeze heater 1	Antifreeze heater 2	Antifreeze heater 1	Antifreeze heater 2	
11	Cumulative fault alarms	Cumulative fault alarms	Cumulative fault alarms	Cumulative fault alarms	
12	Condenser fans Circuit 1	Condenser fans Circuit 3	Condenser fans Circuit 1/2	Condenser fans Circuit 3/4	
13	Condenser fans Circuit 2	Condenser fans Circuit 4	Valve C		

Analogue outputs

		Chillers with Heat Pump		Chillers with Heat Pump and complete recovery	
no	Master	Slave no.1-3	Master	Slave no.1-3	
1	Condenser fan 1 speed cont.	Condenser fan 3 speed cont.	Condenser fan 1 speed cont.	Condenser fan 3 speed cont.	
2	Condenser fan 2 speed cont.	Condenser fan 4 speed cont.			

3.5 AIR/AIR units with maximum 8 semi-hermetic compressors (1 cap. stage per compressor)

Digital inputs

AIR/AIR condensing units MACHINE TYPE "12"			Chiller with Condensing heat pump MACHINE TYPE "13"	
no	Master	Slave no.1-3	Master	Slave no.1-3
1	Serious alarm	Serious alarm (can be enabled)	Serious alarm	Serious alarm (can be enabled)
2	Evaporator flow switch	Evaporator flow switch (enable)	Evaporator flow switch	Evaporator flow switch (enable)
3	Remote ON/OFF		Remote ON/OFF	
4	Main fan thermal overload		Cooling/heating switch	
5	Low press. switch 1	Low press. switch 3	Low press. switch 1	Low press. switch 3
6	Oil differential 1	Oil differential 3	Oil differential 1	Oil differential 3
7	Fan 1 thermal overload	Fan 3 thermal overload	Fan 1 thermal overload	Fan 3 thermal overload
8	Low press. switch 2	Low press. switch 4	Low press. switch 2	Low press. switch 4
9	Oil differential 2	Oil differential 4	Oil differential 2	Oil differential 4
10	Fan 2 thermal overload	Fan 4 thermal overload	Fan 2 thermal overload	Fan 4 thermal overload
11	High press. switch. 1 / Comp. 1 thermal overload	High press. switch. 3 / Comp. 3 thermal overload	High press. switch. 1 / Comp. 1 thermal overload	High press. switch. 3 / Comp. 3 thermal overload
12	High press. switch. 2 / Comp. 2 thermal overload	High press. switch. 4 / Comp. 4 thermal overload	High press. switch. 2 / Comp. 2 thermal overload	High press. switch. 4 / Comp. 4 thermal overload

Analogue inputs

AIR/AIR condensing units			Chiller with Condensing heat pump	
no	Master	Slave no.1-3	Master	Slave no.1-3
1				
2	Air outlet temp. 1	Air outlet temp. 2	Air outlet temp. 1	Air outlet temp. 2
3	Condensing temp. Circuit 1	Condensing temp. Circuit 3	Condensing temp. Circuit 1	Condensing temp. Circuit 3
4	Condensing temp. Circuit 2	Condensing temp. Circuit 4	Condensing temp. Circuit 2	Condensing temp. Circuit 4
5	Remote compressor control		Remote compressor control	
6				
7	High pressure transducers circuit 1	High pressure transducers circuit 3	High pressure transducers circuit 1	High pressure transducers circuit 3
8	High pressure transducers circuit 2	High pressure transducers circuit 4	High pressure transducers circuit 2	High pressure transducers circuit 4

Digital outputs

AIR/AIR condensing units			Chiller with Condensing heat pump	
no	Master	Slave no.1-3	Master	Slave no.1-3
1	Fan Circulation		Fan Circulation	
2	Winding a comp.1	Winding a comp.3	Winding a comp.1	Winding a comp.3
3	Winding b comp.1	Winding b comp.3	Winding b comp.1	Winding b comp.3
4	Liquid solenoid circuit 1	Liquid solenoid circuit 3	Liquid solenoid circuit 1	Liquid solenoid circuit 3
5	Capacity-control comp.1	Capacity-control comp.3	Capacity-control comp.1	Capacity-control comp.3
6	Winding a comp.2	Winding a comp.4	Winding a comp.2	Winding a comp.4
7	Winding b comp.2	Winding b comp.4	Winding b comp.2	Winding b comp.4
8	Liquid solenoid circuit 2	Liquid solenoid circuit 4	Liquid solenoid circuit 2	Liquid solenoid circuit 4
9	Capacity-control comp.2	Capacity-control comp.4	Capacity-control comp.2	Capacity-control comp.4
10	Antifreeze heater 1	Antifreeze heater 2	Antifreeze heater 1	Antifreeze heater 2
11	Cumulative fault alarms	Cumulative fault alarms	Cumulative fault alarms	Cumulative fault alarms
12	Condenser fans Circuit 1	Condenser fans Circuit 3	Condenser fans Circuit 1	Condenser fans Circuit 3
13	Condenser fans Circuit 2	Condenser fans Circuit 4	Condenser fans Circuit 2	Condenser fans Circuit 4

Analogue outputs

AIR/AIR condensing units			Chiller with Condensing heat pump	
no	Master	Slave no.1-3	Master	Slave no.1-3
1	Condenser fan 1 speed cont.	Condenser fan 3 speed cont.	Condenser fan 1 speed cont.	Condenser fan 3 speed cont.
2	Condenser fan 2 speed cont.	Condenser fan 4 speed cont.	Condenser fan 2 speed cont.	Condenser fan 4 speed cont.

3.6 WATER/WATER units with maximum 8 semi-hermetic compressors (1 cap. stage per compressor)

Digital inputs

Chiller-only unit MACHINE TYPE "14"		Cooling/heating unit with water reversal MACHINE TYPE "15"		
no	Master	Slave no.1-3	Master	Slave no.1-3
1	Serious alarm	Serious alarm (can be enabled)	Serious alarm	Serious alarm (can be enabled)
2	Evaporator flow switch	Evaporator flow switch (enable)	Evaporator flow switch	Evaporator flow switch (enable)
3	Remote ON/OFF		Remote ON/OFF	
4	Pump thermal overload		Cooling/heating switch	
5	Low pressure switch 1	Low pressure switch 3	Low pressure switch 1	Low pressure switch 3
6	Oil differential 1	Oil differential 3	Oil differential 1	Oil differential 3
7	Condenser water flow switch	Condenser water flow switch (can be enabled)	Condenser water flow switch	Condenser water flow switch (can be enabled)
8	Low pressure switch 2	Low pressure switch 4	Low pressure switch 2	Low pressure switch 4
9	Oil differential 2	Oil differential 4	Oil differential 2	Oil differential 4
10	Condenser pump thermal overload		Condenser pump thermal overload	
11	High pressure switch 1 / Comp. 1 thermal overload	High pressure switch 3 / Comp. 3 thermal overload	High pressure switch 1 / Comp. 1 thermal overload	High pressure switch 3 / Comp. 3 thermal overload
12	High pressure switch 2 / Comp. 2 thermal overload	High pressure switch 4 / Comp. 4 thermal overload	High pressure switch 2 / Comp. 2 thermal overload	High pressure switch 4 / Comp. 4 thermal overload

Analogue inputs

Chiller-only unit		Cooling/heating unit with water reversal		
no	Master	Slave no.1-3	Master	Slave no.1-3
1	Evap. water inlet temp.		Evap. water inlet temp.	
2	Evap. 1 water outlet temp.	Evap. 2 water outlet temp.	Evap. 1 water outlet temp.	Evap. 2 water outlet temp.
3	Condenser 1 water inlet temp.	Condenser 2 water inlet temp.	Condenser 1 water inlet temp.	Condenser 2 water inlet temp.
4	Condenser 1 water outlet temp.	Condenser 2 water outlet temp.	Condenser 1 water outlet temp.	Condenser 2 water outlet temp.
5	Outside set point		Outside set point	
6				
7	High pressure transducers circuit 1	High pressure transducers circuit 3	High pressure transducers circuit 1	High pressure transducers circuit 3
8	High pressure transducers circuit 2	High pressure transducers circuit 4	High pressure transducers circuit 2	High pressure transducers circuit 4

Digital outputs

Chiller-only unit		Cooling/heating unit with water reversal		
no	Master	Slave no.1-3	Master	Slave no.1-3
1	Evap. pump		Evap. pump	
2	Winding a comp.1	Winding a comp.3	Winding a comp.1	Winding a comp.3
3	Winding b comp.1	Winding b comp.3	Winding b comp.1	Winding b comp.3
4	Liquid solenoid circuit 1	Liquid solenoid circuit 3	Liquid solenoid circuit 1	Liquid solenoid circuit 3
5	Capacity-control comp.1	Capacity-control comp.3	Capacity-control comp.1	Capacity-control comp.3
6	Winding a comp.2	Winding a comp.4	Winding a comp.2	Winding a comp.4
7	Winding b comp.2	Winding b comp.4	Winding b comp.2	Winding b comp.4
8	Liquid solenoid circuit 2	Liquid solenoid circuit 4	Liquid solenoid circuit 2	Liquid solenoid circuit 4
9	Capacity-control comp.2	Capacity-control comp.4	Capacity-control comp.2	Capacity-control comp.4
10	Antifreeze heater 1	Antifreeze heater 2	Antifreeze heater 1	Antifreeze heater 2
11	Cumulative fault alarms	Cumulative fault alarms	Cumulative fault alarms	Cumulative fault alarms
12	Condenser pump		Condenser pump	
13			Heat/Cool valve	

Analogue outputs

Chiller-only unit		Cooling/heating unit with water reversal		
no	Master	Slave no.1-3	Master	Slave no.1-3
1				
2				

3.7 AIR/WATER units with maximum 4 semi-hermetic compressors (up to 3 cap. stages per comp.)

Digital inputs

Chiller-only unit MACHINE TYPE "16"			Chiller unit with freecooling MACHINE TYPE "17"	
no	Master	Slave no.1-3	Master	Slave no.1-3
1	Serious alarm	Serious alarm (can be enabled)	Serious alarm	Serious alarm (can be enabled)
2	Evaporator flow switch	Evaporator flow switch (enable)	Evaporator flow switch	Evaporator flow switch (enable)
3	Remote ON/OFF		Remote ON/OFF	
4	Pump thermal overload		Pump thermal overload	
5	Low pressure switch 1	Low pressure switch 2	Low pressure switch 1	Low pressure switch 2
6	Oil differential 1	Oil differential 2	Oil differential 1	Oil differential 2
7	Fan 1 thermal overload circuit 1	Fan 1 thermal overload circuit 2	Fan 1 thermal overload circuit 1	Fan 1 thermal overload circuit 2
8	Fan 2 thermal overload circuit 1	Fan 2 thermal overload circuit 2	Fan 2 thermal overload circuit 1	Fan 2 thermal overload circuit 2
9	Fan 3 thermal overload circuit 1	Fan 3 thermal overload circuit 2	Fan 3 thermal overload circuit 1	Fan 3 thermal overload circuit 2
10				
11	High pressure switch 1	High pressure switch 2	High pressure switch 1	High pressure switch 2
12	Comp. 1 thermal overload	Comp. 3 thermal overload	Comp. 1 thermal overload	Comp. 3 thermal overload

Analogue inputs

Chiller-only unit			Chiller unit with freecooling	
no	Master	Slave no.1-3	Master	Slave no.1-3
1	Water inlet temp.		Water inlet temp.	
2	Water outlet temp. 1	Water outlet temp. 2	Water outlet temp. 1	Water outlet temp. 2
3	Condensing temp. Circuit 1	Condensing temp. Circuit 2	Condensing temp. Circuit 1	Condensing temp. Circuit 2
4			Outside temperature	
5	Outside set point		Outside set point	
6			Freecooling temperature	
7	High pressure transducers circuit 1	High pressure transducers circuit 2	High pressure transducers circuit 1	High pressure transducers circuit 2
8				

Digital outputs

Chiller-only unit			Chiller unit with freecooling	
no	Master	Slave no.1-3	Master	Slave no.1-3
1	Pump		Pump	
2	Winding a comp.1	Winding a comp.2	Winding a comp.1	Winding a comp.2
3	Winding b comp.1	Winding b comp.2	Winding b comp.1	Winding b comp.2
4	Liquid solenoid circuit 1	Liquid solenoid circuit 2	Liquid solenoid circuit 1	Liquid solenoid circuit 2
5	Condenser fan 3 Circ. 1	Condenser fan 3 Circ. 2	Condenser fan 3 Circ. 1	Condenser fan 3 Circ. 2
6	Stage 1 comp.1	Stage 1 comp.2	Stage 1 comp.1	Stage 1 comp.2
7	Stage 2 comp.1	Stage 2 comp.2	Stage 2 comp.1	Stage 2 comp.2
8	Stage 3 comp.1	Stage 3 comp.2	Stage 3 comp.1	Stage 3 comp.2
9	Condenser fan 2 Circ. 1	Condenser fan 2 Circ. 2	Condenser fan 2 Circ. 1	Condenser fan 2 Circ. 2
10	Antifreeze heater 1	Antifreeze heater 2	Antifreeze heater 1	Antifreeze heater 2
11	Cumulative fault alarms	Cumulative fault alarms	Cumulative fault alarms	Cumulative fault alarms
12	Condenser fan 1 Circ. 1	Condenser fan 1 Circ. 2	Condenser fan 1 Circ. 1	Condenser fan 1 Circ. 2
13			Freecooling On / Off	

Analogue outputs

Chiller-only unit			Chiller unit with freecooling	
no	Master	Slave no.1-3	Master	Slave no.1-3
1	Condenser fan 1 speed cont.	Condenser fan 2 speed cont.	Condenser fan 1 speed cont.	Condenser fan 2 speed cont.
2			Modulating freecooling valve	

Digital inputs

Chillers with Heat Pump MACHINE TYPE "18"			Chiller with heat p. and complete recovery MACHINE TYPE "19"	
no	Master	Slave no.1-3	Master	Slave no.1-3
1	Serious alarm	Serious alarm (can be enabled)	Serious alarm	Serious alarm (can be enabled)
2	Evaporator flow switch	Evaporator flow switch (enable)	Evaporator flow switch	Evaporator flow switch (enable)
3	Remote ON/OFF		Remote ON/OFF	
4	Cooling / heating switch		Cooling / heating switch	
5	Low pressure switch 1	Low pressure switch 2	Low pressure switch 1	Low pressure switch 2
6	Oil differential 1	Oil differential 2	Oil differential 1	Oil differential 2
7	Fan 1 thermal overload circuit 1	Fan 1 thermal overload circuit 2	Fan 1 thermal overload circuit 1	Fan 1 thermal overload circuit 2
8	Fan 2 thermal overload circuit 1	Fan 2 thermal overload circuit 2	Fan 2 thermal overload circuit 1	Fan 2 thermal overload circuit 2
9	Fan 3 thermal overload circuit 1	Fan 3 thermal overload circuit 2	Fan 3 thermal overload circuit 1	Fan 3 thermal overload circuit 2
10	Pump thermal overload		Pump thermal overload	
11	High pressure switch 1	High pressure switch 2	High pressure switch 1	High pressure switch 2
12	Comp. 1 thermal overload	Comp. 2 thermal overload	Comp. 1 thermal overload	Comp. 2 thermal overload

Analogue inputs

Chillers with Heat Pump			Chillers with Heat Pump and complete recovery	
no	Master	Slave no.1-3	Master	Slave no.1-3
1	Water inlet temp.		Water inlet temp.	
2	Water outlet temp. 1	Water outlet temp. 2	Water outlet temp. 1	Water outlet temp. 2
3	Condensing temp. Circuit 1	Condensing temp. Circuit 2	Condensing temp. Circuit 1	Condensing temp. Circuit 2
4			Recovery boiler inlet temp.	
5	Outside set point		Outside set point	
6			Recovery boiler outlet temp.	
7	High pressure transducers circuit 1	High pressure transducers circuit 2	High pressure transducers circuit 1	High pressure transducers circuit 2
8				

Digital outputs

Chillers with Heat Pump	Chillers with Heat Pump and complete recovery
-------------------------	---

3.8 AIR/AIR units with maximum 4 semi-hermetic compressors (up to 3 cap. stages per comp.)

Digital inputs

		Condensing unit MACHINE TYPE "20"		Condensing with Heat Pump MACHINE TYPE "21"	
no	Master	Slave no.1-3	Master	Slave no.1-3	Slave no.1-3
1	Serious alarm	Serious alarm (can be enabled)	Serious alarm	Serious alarm (can be enabled)	Serious alarm (can be enabled)
2	Evaporator flow switch	Evaporator flow switch (enable)	Evaporator flow switch	Evaporator flow switch (enable)	Evaporator flow switch (enable)
3	Remote ON/OFF		Remote ON/OFF		
4	Main fan thermal overload		Cooling / heating switch		
5	Low pressure switch 1	Low pressure switch 2	Low pressure switch 1	Low pressure switch 2	Low pressure switch 2
6	Oil differential 1	Oil differential 2	Oil differential 1	Oil differential 2	Oil differential 2
7	Fan 1 thermal overload circuit 1	Fan 1 thermal overload circuit 2	Fan 1 thermal overload circuit 1	Fan 1 thermal overload circuit 2	Fan 1 thermal overload circuit 2
8	Fan 2 thermal overload circuit 1	Fan 2 thermal overload circuit 2	Fan 2 thermal overload circuit 1	Fan 2 thermal overload circuit 2	Fan 2 thermal overload circuit 2
9	Fan 3 thermal overload circuit 1	Fan 3 thermal overload circuit 2	Fan 3 thermal overload circuit 1	Fan 3 thermal overload circuit 2	Fan 3 thermal overload circuit 2
10					
11	High pressure switch 1	High pressure switch 2	High pressure switch 1	High pressure switch 2	High pressure switch 2
12	Comp. 1 thermal overload	Comp. 2 thermal overload	Comp. 1 thermal overload	Comp. 2 thermal overload	Comp. 2 thermal overload

Analogue inputs

		AIR/AIR condensing units		AIR/AIR units with Condensing heat pump	
no	Master	Slave no.1-3	Master	Slave no.1-3	Slave no.1-3
1					
2	Water outlet temp. 1	Water outlet temp. 2	Water outlet temp. 1	Water outlet temp. 2	Water outlet temp. 2
3	Condensing temp. Circuit 1	Condensing temp. Circuit 2	Condensing temp. Circuit 1	Condensing temp. Circuit 2	Condensing temp. Circuit 2
4					
5	Remote compressor control		Remote compressor control		
6					
7	High pressure transducers circuit 1	High pressure transducers circuit 2	High pressure transducers circuit 1	High pressure transducers circuit 2	High pressure transducers circuit 2
8					

Digital outputs

		AIR/AIR condensing units		AIR/AIR units with Condensing heat pump	
no	Master	Slave no.1-3	Master	Slave no.1-3	Slave no.1-3
1	Fan Circulation		Fan Circulation		
2	Winding a comp.1	Winding a comp.2	Winding a comp.1	Winding a comp.2	Winding a comp.2
3	Winding b comp.1	Winding b comp.2	Winding b comp.1	Winding b comp.2	Winding b comp.2
4	Liquid solenoid circuit 1	Liquid solenoid circuit 2	Liquid solenoid circuit 1	Liquid solenoid circuit 2	Liquid solenoid circuit 2
5	Condenser fan 3 Circ. 1	Condenser fan 3 Circ. 2	Condenser fan 3 Circ. 1	Condenser fan 3 Circ. 2	Condenser fan 3 Circ. 2
6	Stage 1 comp.1	Stage 1 comp.2	Stage 1 comp.1	Stage 1 comp.2	Stage 1 comp.2
7	Stage 2 comp.1	Stage 2 comp.2	Stage 2 comp.1	Stage 2 comp.2	Stage 2 comp.2
8	Stage 3 comp.1	Stage 3 comp.2	Stage 3 comp.1	Stage 3 comp.2	Stage 3 comp.2
9	Condenser fan 2 Circ. 1	Condenser fan 2 Circ. 2	Condenser fan 2 Circ. 1	Condenser fan 2 Circ. 2	Condenser fan 2 Circ. 2
10	Antifreeze heater 1	Antifreeze heater 2	Antifreeze heater 1	Antifreeze heater 2	Antifreeze heater 2
11	Cumulative fault alarms	Cumulative fault alarms	Cumulative fault alarms	Cumulative fault alarms	Cumulative fault alarms
12	Condenser fan 1 Circ. 1	Condenser fan 1 Circ. 2	Condenser fan 1 Circ. 1	Condenser fan 1 Circ. 2	Condenser fan 1 Circ. 2
13			4-way valve	4-way valve	4-way valve

Analogue outputs

		AIR/AIR condensing units		AIR/AIR units with Condensing heat pump	
no	Master	Slave no.1-3	Master	Slave no.1-3	Slave no.1-3
1	Condenser fan 1 speed cont.	Condenser fan 2 speed cont.	Condenser fan 1 speed cont.	Condenser fan 2 speed cont.	Condenser fan 2 speed cont.
2					

3.9 WATER/WATER units with maximum 4 semi-hermetic compressors (up to 3 cap. stages per comp.)

Digital inputs

Chiller-only unit MACHINE TYPE "22"		Cooling/heating unit with water reversal MACHINE TYPE "23"		
no	Master	Slave no.1-3	Master	Slave no.1-3
1	Serious alarm	Serious alarm (can be enabled)	Serious alarm	Serious alarm (can be enabled)
2	Evaporator flow switch	Evaporator flow switch (enable)	Evaporator flow switch	Evaporator flow switch (enable)
3	Remote ON/OFF		Remote ON/OFF	
4	Pump thermal overload		Cooling / heating switch	
5	Low pressure switch 1	Low pressure switch 2	Low pressure switch 1	Low pressure switch 2
6	Oil differential 1	Oil differential 2	Oil differential 1	Oil differential 2
7	Condenser flow switch	Condenser flow switch (can be enabled)	Condenser flow switch	Condenser flow switch (can be enabled)
8				
9			Evaporator pump thermal overload	
10	Condenser pump thermal overload		Condenser pump thermal overload	
11	High pressure switch 1	High pressure switch 2	High pressure switch 1	High pressure switch 2
12	Compressor 1 thermal overload	Compressor 2 thermal overload	Compressor 1 thermal overload	Compressor 2 thermal overload

Analogue inputs

Chiller-only unit		Chiller unit with water reversal		
no	Master	Slave no.1-3	Master	Slave no.1-3
1	Water inlet temp.		Water inlet temp.	
2	Water outlet temp. 1	Water outlet temp. 2	Water outlet temp. 1	Water outlet temp. 2
3	Condensing temp. Input 1	Condenser 2 water inlet temp.	Condensing temp. Input 1	Condenser 2 water inlet temp.
4	Condenser 1 water outlet temp.	Condenser 2 water outlet temp.	Condenser 1 water outlet temp.	Condenser 2 water outlet temp.
5	Outside set point		Outside set point	
6				
7	High pressure transducers circuit 1	High pressure transducers circuit 2	High pressure transducers circuit 1	High pressure transducers circuit 2
8				

Digital outputs

Chiller-only unit		Chiller unit with water reversal		
no	Master	Slave no.1-3	Master	Slave no.1-3
1	Evap. pump		Evap. pump	
2	Winding a comp.1	Winding a comp.2	Winding a comp.1	Winding a comp.2
3	Winding b comp.1	Winding b comp.2	Winding b comp.1	Winding b comp.2
4	Liquid solenoid circuit 1	Liquid solenoid circuit 2	Liquid solenoid circuit 1	Liquid solenoid circuit 2
5			Reversing valve water	
6	Stage 1 comp.1	Stage 1 comp.2	Stage 1 comp.1	Stage 1 comp.2
7	Stage 2 comp.1	Stage 2 comp.2	Stage 2 comp.1	Stage 2 comp.2
8	Stage 3 comp.1	Stage 3 comp.2	Stage 3 comp.1	Stage 3 comp.2
9	Condenser pump		Condenser pump	
10	Antifreeze heater 1	Antifreeze heater 2	Antifreeze heater 1	Antifreeze heater 2
11	Cumulative fault alarms	Cumulative fault alarms	Cumulative fault alarms	Cumulative fault alarms
12				
13				

Analogue outputs

Chiller-only unit		Chiller unit with water reversal		
NO	Master	Slave no.1-3	Master	Slave no.1-3
1				
2				

4. Control

4.1 Inlet temperature control

Inputs used

- Inlet temperature

Outputs used

- All the compressors and the corresponding capacity stages

Parameters used

- Control set point
- Proportional band for inlet control.
- Type of control (proportional or proportional + integral)
- Integration time (if proportional + integral control is enabled)
- Type of unit
- Total number of compressors
- Number of capacity-control steps

Example: control diagram for machines with max 8 semi-hermetic compressors, max one capacity stage each

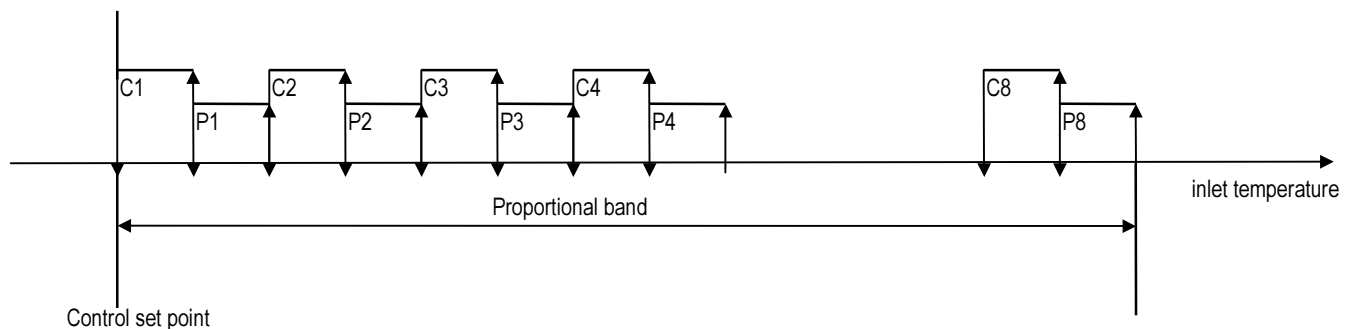

All the compressors in the network will be positioned proportionally across the band.

4.2 Outlet temperature control

Inputs used

- Outlet temperature

Outputs used

- All the compressors and the corresponding capacity stages

Parameters used

- Control set point
- Dead zone for outlet control
- Step activation time
- Step deactivation time
- Minimum outlet temperature limit (stops all the compressors without observing the deactivation time)
- Maximum outlet temperature limit (stops all the compressors without observing the deactivation time)

Outlet temperature control diagram:

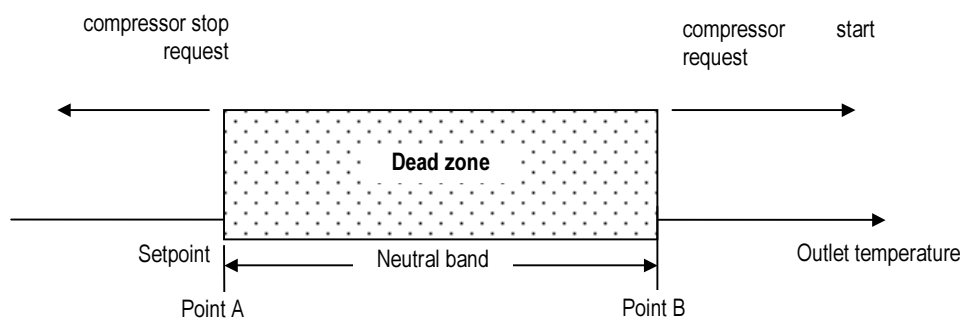

While the temperature remains inside the dead zone, no compressor is activated or deactivated (outlet temperature between point A and point B)

Compressor activation request (outlet temperature higher than point B):

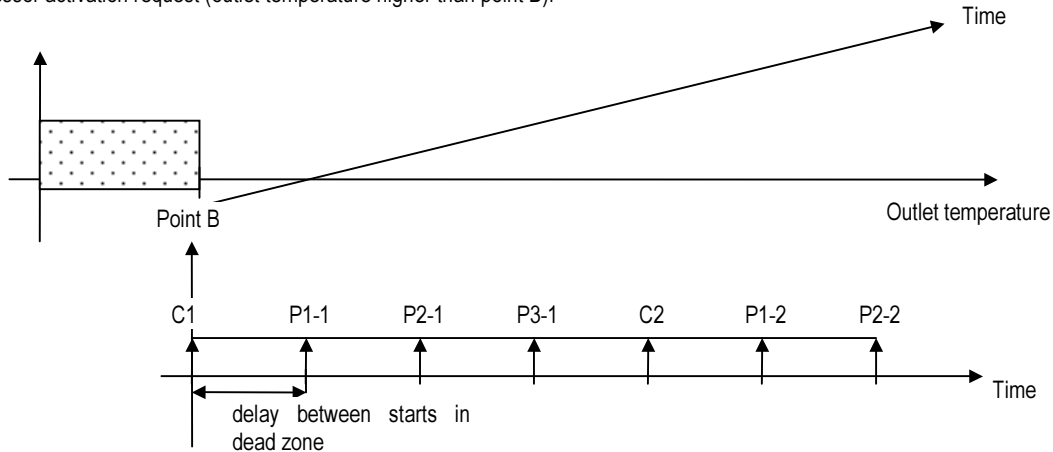

When the temperature is higher than point B, the compressors are activated, with a delay between successive starts equal to the value of the parameter "delay between starts in the dead zone".

Deactivation of the active devices:

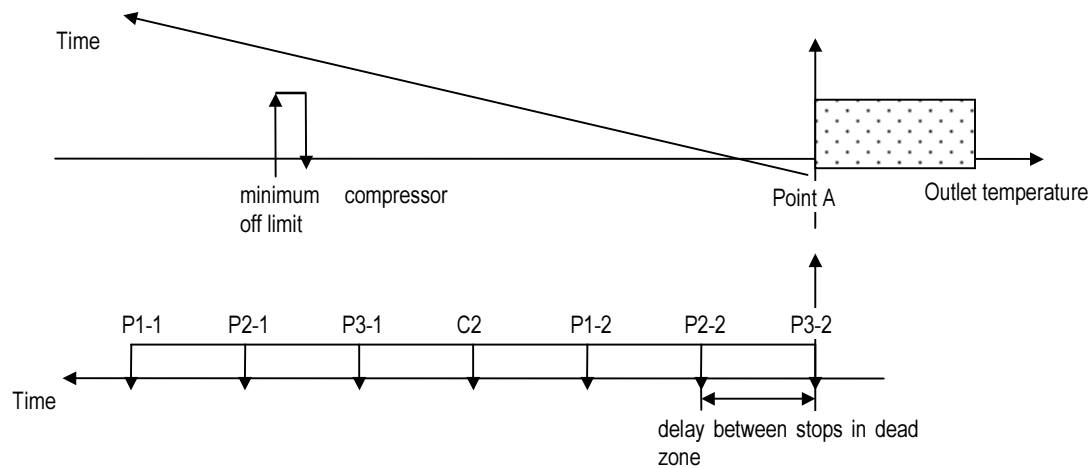

When the temperature is lower than point A, the compressors are deactivated, with a delay between successive stops equal to the value of the parameter "delay between stops in the dead zone".

If the temperature falls below the minimum limit, the compressors are forced off even if the times have not elapsed (this prevent functions the antifreeze alarm being activated).

4.3 Compressor rotation

The compressor calls are rotated so as to balance the number of operating hours and starts between the devices. Rotation follows FIFO logic, which means that the first compressor to start will be the first to stop. Initially there may be large differences between on the operating hours of the various compressors, however in normal operating conditions the number of hours will tend to balance out. Rotation is only performed between the compressors and not between the capacity-control steps.

Management without rotation:

- Start: C1,C2,C3,C4,C5,C6,...,C16.
- Stop: C16,C15,C14,C13,C12,C11,...,C1.

Management with FIFO rotation (the first compressor that starts will be the first to stop):

- Start: C1,C2,C3,C4,C5,C6,...,C16.
- Stop: C1,C2,C3,C4,C5,...,C16.

4.4 Condenser control

Inputs used

- C1 high pressure probe B7
- C2 high pressure probe B8
- C1 coil temperature probe B3
- C2 coil temperature probe B4

Outputs used

- Fan 1
- Fan 2
- Fan 3
- C1 fan speed control AOUT1
- C2 fan speed control AOUT2

Parameters used

- Select condenser control: none/pressure/temperature
- Type of condenser coil (Single / Separate)
- Condenser control set point
- Condenser control band
- Number of fans per coil
- Enable prevent function
- Prevent threshold
- Prevent differential
- Output voltage corresponding to minimum inverter speed
- Output voltage corresponding to maximum inverter speed
- Inverter speed-up time

Condenser control can be performed as follows:

- on/off, linked to the operation of the compressors (without the pressure transducers)
- on/off or modulating linked to the reading of the pressure transducer (if the high pressure transducers are enabled)
- on/off or modulating linked to the reading of coil temperature probes 1 and 2 (if the coil temperature probes are enabled)

4.4.1 On/off condenser control linked to compressor operation:

With this type of condenser control, the operation of the fans is subordinate only to the operation of the compressors:

Compressor off = fan off

Compressor on = fan on

4.4.2 On/off condenser control linked to the pressure or temperature sensor:

With this type of condenser control, the operation of the fans is subordinate to the operation of the compressors and to the value read by the pressure or temperature sensors, according to a set point and a band. When the pressure/temperature is less than or equal to the set point, all the fans are off; when the pressure/temperature rises to the set-point + band, all the fans are started.

Single- or separate-coil condenser control can be selected; with single-coil condenser control, the fans are controlled according to the highest pressure/temperature; with separate-coil condenser control, each pressure/temperature sensor controls its own fan.

4.4.3 Modulating condenser control linked to the pressure or temperature sensor:

With this type of condenser control, the fans are controlled using a 0/10V analogue output proportional to the request of the pressure/temperature sensor. Single- or separate-coil condenser control can also be selected for this mode, as described above. If the lower limit of the ramp is greater than 0V, the line will not be proportional but rather, as seen in the first section of the graph, one step below the setpoint-diff.

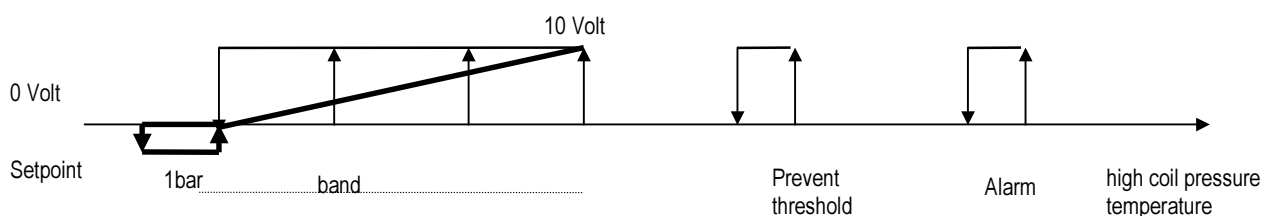

4.4.4 Prevent function:

As well as the high pressure alarm set point and differential, a high pressure prevention set point and differential can also be set. This function can be selected on entering the manufacturer password, and is used to avoid the circuits being shut-down due to high pressure. With the compressor on, when this threshold is reached the compressor is forced to capacity-control operation, until the pressure falls below the set point minus a differential value that can be set (set - diff.). With the compressor off, when this threshold is reached the fans are forced on, until the pressure falls below the set minus the differential.

```
M_Manuf80
+-----+
|Prevent enable   N|
|Probe    PRESSURE|
|Setpoint    00.0---|
|Diff.      00.0---|
+-----+
```

```
M_Manuf82
+-----+
|Prevent
|Unloads switching on|
|delay      00s|
|Exit delay 000s|
+-----+
```

In addition, a delay can be set for the activation of the individual capacity-control steps (obviously, this is valid only if there are 2 or 3 stages per compressor) and for the end of the prevent function. That is, the prevent condition is maintained (for the set time) even when the temperature falls below the set-diff.

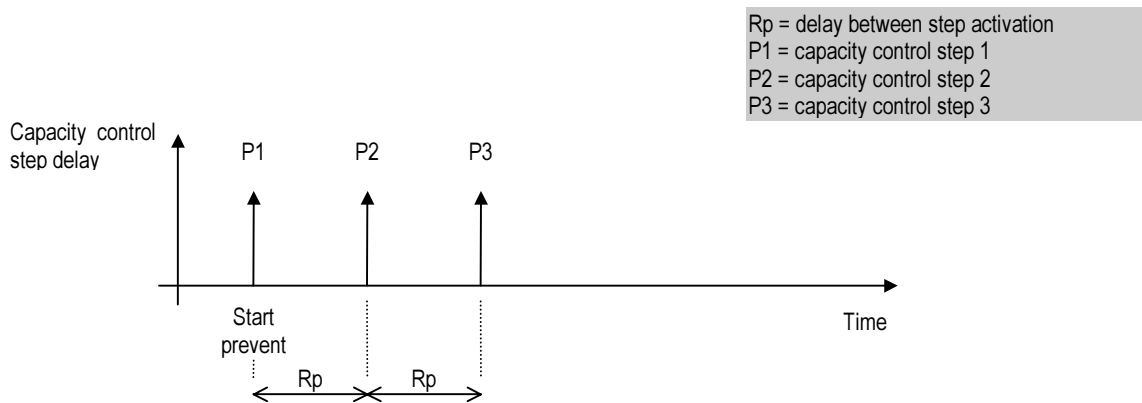

4.5 Defrost control for water/air machines

Inputs used

- coil temperature 1 (can be used as a pressure switch)
- coil temperature 2 (can be used as a pressure switch)
- defrost pressure switch 1
- defrost pressure switch 2

Parameters used

- Inputs used for defrost
- Type of global defrost (simultaneous / separate)
- Type of local defrost (simultaneous / separate)
- Start defrost set point
- End defrost set point
- Defrost delay time
- Maximum defrost time
- compressor off time

Outputs used

- Compressor 1
- Compressor 2
- Compressor 3
- Compressor 4
- Reverse cycle solenoid valve 1
- Reverse cycle solenoid valve 2
- Fan circuit no.1
- Fan circuit no.2

4.5.1 Type of defrost 1: simultaneous global / simultaneous local

Only one circuit needs to enter in the defrost cycle for all the circuits to be forced to defrost; the circuits which do not require defrost (temperature greater than the end defrost set point) stop and go to stand-by; as soon as all the circuits end their defrost cycle the compressors can start again in heat pump operation.

4.5.2 Type of defrost 2: separate global / simultaneous local

This type of defrost involves separate defrosts between the various pCO units, and a simultaneous defrost within the same pCO unit: The first pCO unit that requests defrost starts defrosting (simultaneous within the unit), while the other units, even if they require defrost, go to stand-by (continue to operate in heat pump mode) until the first ends its defrost; when the first unit ends defrosting, the following unit starts defrosting if required (simultaneous within the unit) while the others remain in stand-by.

4.5.3 Type of defrost 3: separate global / separate local

With this type of defrost, each refrigerant circuit starts defrosting separately; the first circuit that requires defrosting starts the defrost cycle, while the other circuits, remain in stand-by until the first finishes its defrost, even if they require defrosting; when the first finishes its defrost, the following unit starts defrosting and the others remain in stand-by.

```
M_Manuf130
+-----+
|Defrost config. |
|Probe  TEMPERATURE |
|Global  SIMULTANEOUS |
|Local   SIMULTANEOUS |
+-----+
```

Circuit defrosting with time/temperature control:

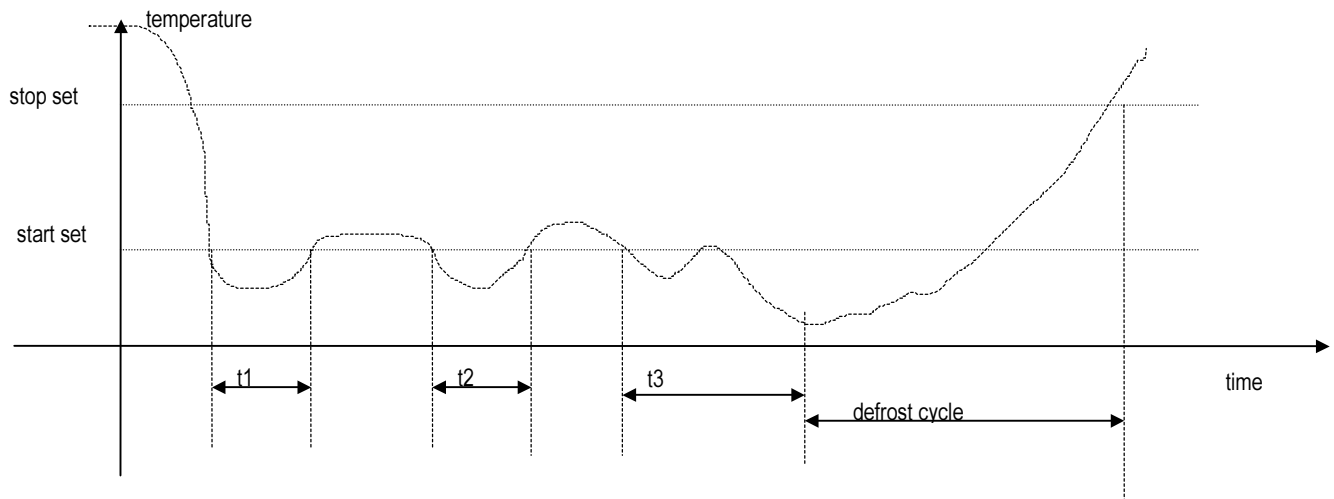

If the temperature/pressure of a coil remains below the start defrost set point for a cumulative time equal to the defrost delay time, the circuit in question will start a defrost cycle:

- the system is taken to maximum refrigeration capacity
- the refrigerant circuit is reversed using 4-way valve
- the fan in question is switched off (if the pressure probes are present, the fan can be started at a certain threshold to prevent the circuit from reaching the high pressure alarm)

The circuit exits the defrost cycle due to the temperature/pressure (if the coil temperature exceeds the end defrost set point) or after a maximum time, if the defrost cycle exceeds the maximum set threshold time.

Circuit defrosting with time/pressure switch control:

The control is exactly the same, the only difference is the fact the temperature/pressure is no longer counted, but rather the status of the pressure-switches.

```
M_User50
+-----+
|Defrost parameters |
|Start      00.08C  |
|Stop      00.08C  |
+-----+
```

```
M_User55
+-----+
|Defrost parameters |
|Delay time  00000s |
|Maximum time 00000s |
+-----+
```

The compressor off time can be set for both the start and end defrost. Setting the time to 0 seconds means the compressors are not switched off.

```
M_User100
+-----+
|Defrost parameters |
|Switch compressor |
|off when defrost  |
|begins/ends for 000s|
+-----+
```

A delay can be set for the reversal of the cooling cycle at the start and end defrost.

```
M_User101
+-----+
|Defrost parameters |
|Reversing cycle   |
|delay            000s|
+-----+
```

The fans are normally off during defrost, and are started only when the pressure probes are enabled and the pressure exceeds the prevent threshold, so as to avoid the high pressure alarm.

4.6 Condensing Unit Control

Inputs used

- Analogue input B5 (proportional) / "fixed" voltage drops (steps)

Outputs used

- All compressors

Parameters used

- Type of unit
- Type of remote control management
- Type of analogue input B5

The type of analogue input B5 can be selected: 0-1V or 4-20mA. The proportional/stepped control described below refers to input B5 selected as 0-1V. For condensing units, the control probes and all the control parameters such as the set point, proportional band etc., are not featured.

4.6.1 Proportional control

```
m_manuf131
+-----+
|Remote compressors |
|control management |
|                    |
|Type  PROPORTIONAL |
+-----+
```

The compressor request depends on analogue input B5:

Analogue input 0V 0% request (no compressor on)

Analogue input 1V 100% request (all compressors on)

When varying inside range of voltage 0-1V, input B5 starts the corresponding "percentage" of compressor capacity.

Example: machine with 2 pCO boards, 4 compressors, 2 per unit with 1 capacity stage per compressor.

Total STEPS = 4 compressors + 4 (comp.) x 1 (stage) = 8

B5 = 0.25V → request = 25% → 25% of 8 steps = 2 steps required → compressor 1 is started at 100% (capacity-control will be "on" or "off" depending on the logic selected).

In addition, there are two safety thresholds that switch the entire unit on or off.

The two points are calculated by the software as follows:

OFF when B5 is below the threshold: $1V / \text{tot. steps} / 2 = 1V / 8 / 2 = 0.0625V$

ON when B5 is above the threshold: $1V - (1V / \text{tot. steps} / 2) = 1V - 0.0625V = 0.9375V$

4.6.2 Stepped control

```
m_manuf131
+-----+
|Remote compressors |
|control management |
|                    |
|Type  STEPS        |
+-----+
```

In stepped control, the compressor request is again provided by analogue input B5, however using a voltage divider (or equivalent circuit/device) that can generate the voltages that switch the compressors on or off.

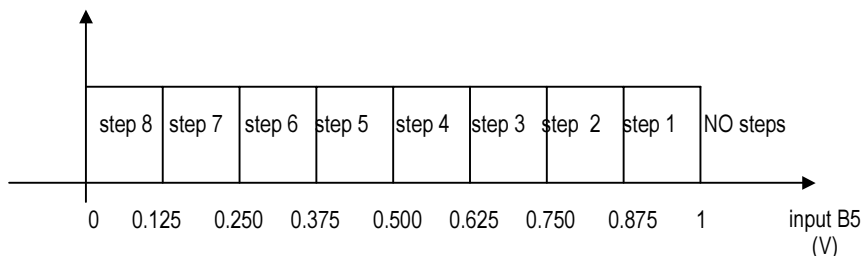

The software automatically generates the compressor On/Off steps.

The graph shows the case of a machine with 8 steps (compressors or mixed compressors/capacity stages). In this case, each step has an amplitude equal to $1V / 8 \text{ steps} = 0.125V$. Therefore, for example, supplying B5 a voltage of 0.680V starts the first 2 steps.

4.7 Control of WATER/WATER units with reversal on the water circuit

Inputs used

- Evaporator water inlet temp. B1
- Evaporator water outlet temp. B2
- Condenser water inlet temp. B3
- Condenser water outlet temp. B4

Outputs used

- relay output for water reversal

Parameters used

- type of unit
- minimum evaporator outlet threshold (if exceeded, inhibits the heating operation)
- reverse cycle valve logic

In cooling operation, the compressors are activated according to the evaporator inlet or outlet temperature B1/B2, while in heating operation the compressors are controlled according to the condenser inlet or outlet temperature. Heating operation is enabled only if the evaporator outlet temperature is higher than the minimum evaporator outlet threshold.

The relay output for water reversal:

cooling operation relay energised

heating operation relay de-energised

(the operating logic of the valve can be selected in the manufacturer parameters)

4.8 Antifreeze control

Inputs used

- Outlet temperature probe

Parameters used

- enable outlet probe
- antifreeze heater set point
- antifreeze heater differential
- antifreeze alarm set point
- antifreeze alarm differential

Outputs used

- antifreeze heater

Each pCO unit can manage the antifreeze function, as long as the outlet temperature probe is connected and enabled.

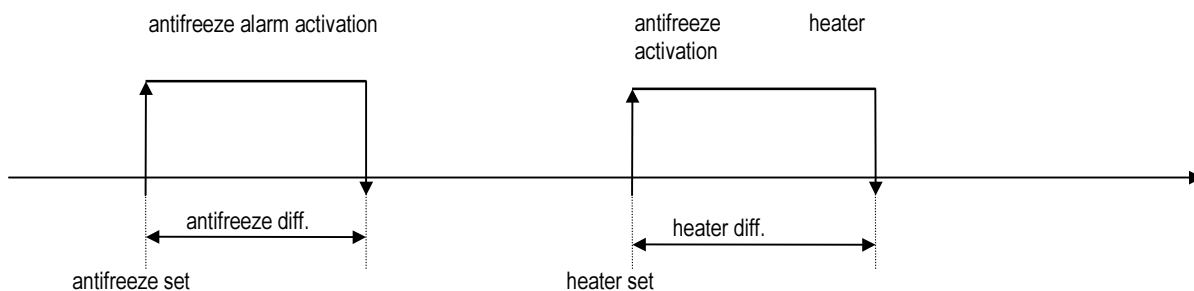

The antifreeze function is always active, even when the machine is off, in both cooling and heating operation.

Note: an antifreeze alarm on any pCO unit shuts down the entire machine.

4.9 Recovery control

Inputs used

- Evaporator water inlet temp. B1
- Evaporator water outlet temp. B2
- Water recovery inlet temp.
- Water recovery outlet temp.

Outputs used

- Valve A
- Valve B
- Valve C

Parameters used

- Priority recovery/utility
- Recovery set point
- Recovery band

4.9.1 Recovery priority

Cooling operation :

When the utility thermoregulator is not at temperature and the recovery thermoregulator is at temperature the machine will be in **chiller-only** operation. The compressors are controlled according to the evaporator water temperature.

When the utility thermoregulator is not at temperature and the recovery thermoregulator is not at temperature the machine will be in **chiller + recovery** operation. The compressors are controlled according to the recovery water temperature.

When the utility thermoregulator is at temperature and the recovery thermoregulator is not at temperature the machine will be in **recovery-only** operation. The compressors are controlled according to the recovery water temperature.

Heating operation :

When the utility thermoregulator is not at temperature and the recovery thermoregulator is at temperature the machine will be in **heat pump** operation. The compressors are controlled according to the evaporator water temperature.

When the utility thermoregulator is not at temperature and the recovery thermoregulator is not at temperature the machine will be in **recovery-only** operation. The compressors are controlled according to the recovery water temperature.

When the utility thermoregulator is at temperature and the recovery thermoregulator is not at temperature the machine will be in **recovery-only** operation. The compressors are controlled according to the recovery water temperature.

If a defrost is required the machine will be in **defrost** operation.

4.9.2 Utility priority

Cooling operation :

When the utility thermoregulator is not at temperature and the recovery thermoregulator is at temperature the machine will be in **chiller-only** operation. The compressors are controlled according to the evaporator water temperature.

When the utility thermoregulator is not at temperature and the recovery thermoregulator is not at temperature the machine will be in **chiller + recovery** operation. The compressors are controlled according to the evaporator water temperature.

When the utility thermoregulator is at temperature and the recovery thermoregulator is not at temperature the machine will be in **recovery-only** operation. The compressors are controlled according to the recovery water temperature.

Heating operation :

When the utility thermoregulator is not at temperature and the recovery thermoregulator is at temperature the machine will be in **heat pump** operation. The compressors are controlled according to the evaporator water temperature.

When the utility thermoregulator is not at temperature and the recovery thermoregulator is not at temperature the machine will be in **heat pump** operation. The compressors are controlled according to the evaporator water temperature.

When the utility thermoregulator is at temperature and the recovery thermoregulator is not at temperature the machine will be in **recovery-only** operation. The compressors are controlled according to the recovery water temperature.

If a defrost is required the machine will be in **defrost** operation.

The condenser fans are on in all operating modes, except for chiller + recovery and defrost.

The various operating modes are selected by the control using the three relays, as shown in the following table

Cooling operation:

	Valve A (recovery)	Valve B (utility)	Valve C (cooling/heating)
Chiller-only	OFF	ON	OFF
Chiller + recovery	ON	ON	OFF
Recovery-only	ON	OFF	OFF

Heating operation

	Valve A (recovery)	Valve B (utility)	Valve C (cooling/heating)
Heat pump	OFF	ON	ON
Recovery-only	ON	OFF	ON
Defrost	OFF	OFF	ON

4.10 Freecooling control

Inputs used

- Evaporator water inlet temperature
- Evaporator water outlet temperature
- Freecooling coil water inlet temperature
- Outside air temperature

Parameters used

- Type of unit
- Number of units
- Type of condenser control
- Number of fans
- Type of freecooling valve
- Control set point
- Freecooling delta
- Freecooling differential
- Maximum freecooling valve opening threshold
- Minimum condenser speed control threshold

Outputs used

- Condenser fans
- Condenser fan speed control
- ON/OFF freecooling valve
- 3-way freecooling valve

4.10.1 Operating description

Freecooling control exploits the temperature of the outside air to assist in the cooling of the utility water.

This function uses a heat exchanger, through which a special valve deviates a certain quantity of return water from the system.

The favourable outside air temperature conditions thus cool the water prior to its return, and the activation of the cooling devices is therefore delayed.

Freecooling is envisaged for AIR/WATER units in internal freecooling mode, that is, with the freecooling coil housed inside the machine near the condenser coil/coils, with which it shares the control of the condenser fan/fans.

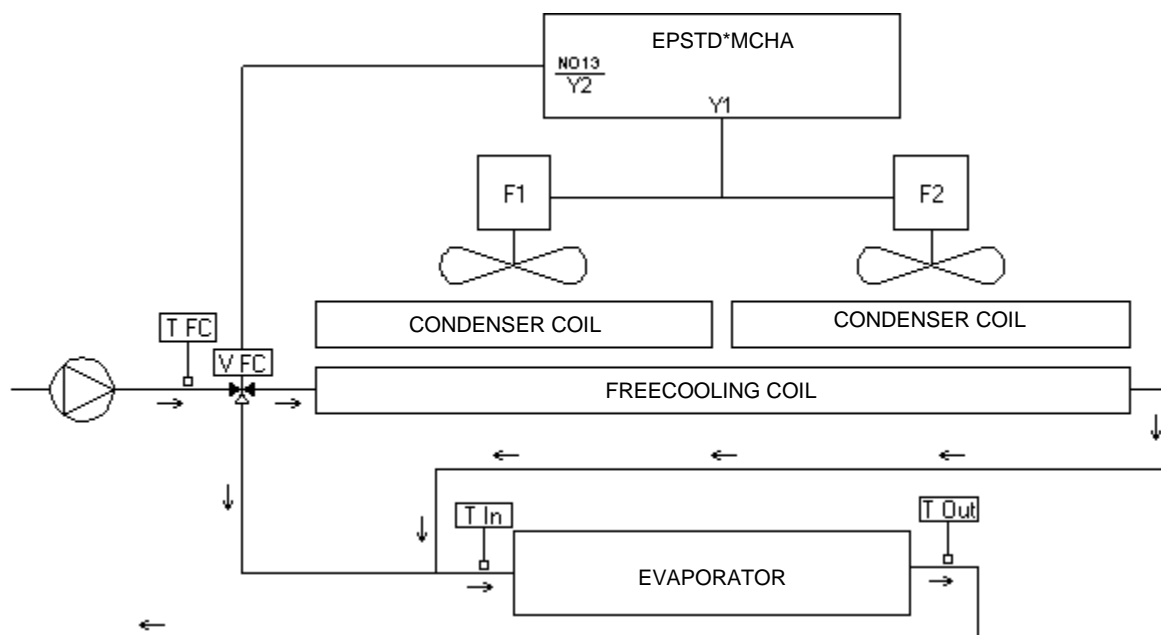

4.11 Activation of the freecooling function

The freecooling function is based on a mathematical equation that compares the temperature measured by the outside temperature probe, the temperature measured by the temperature probe located at the freecooling inlet, and the set freecooling delta.

$$\text{Outside temp.} \leq \text{Freecooling IN temp.} - \text{Freecooling delta}$$

If this condition is true, the freecooling function will be enabled, by activating/deactivating the dedicated devices.

4.12 Freecooling thermostat

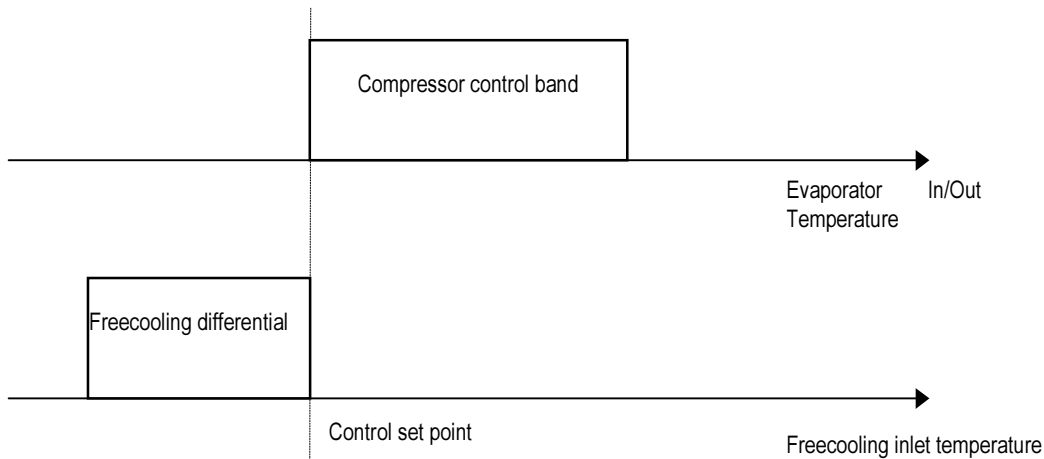

The freecooling function uses the control set point, the freecooling differential and the compressor control band values to identify the zones shown in the graph.

The set point includes any compensation and/or remote set points enabled.

In the freecooling band, identified by temperature values between (Control set point – Freecooling differential) and the control set point, the activation thresholds are calculated for the dedicated devices, such as valves, fans or speed controllers, depending on the mode selected.

When freecooling is active, the condenser fans will be controlled based on the temperature measured by the freecooling coil inlet probe.

If, following an increase in load, the compressors start, the fans will be controlled by the condenser control function.

The freecooling valve will in any case be controlled, and will be completely open as the temperature measured by the freecooling coil inlet probe (in series with the evaporator inlet/outlet probe for the control of the compressors) is higher than the control set point.

The freecooling valve will be closed if and only if the freecooling conditions are no longer true ($\text{Outside temp.} \geq \text{Freecooling temp.} - \text{Freecooling delta}$) or the system return water temperature is less than the activation step of the valve.

The reading of the water temperature probe located at the evaporator outlet is controlled for safety reasons.

Based on the set thresholds, an antifreeze pre-alarm is managed, which activates any post-heaters and switches off all the freecooling devices, along with an antifreeze alarm that shuts down the entire unit.

Other system safety devices, such as: serious alarm from digital input, pump thermal overload, broken control probe, broken antifreeze control probe, evaporator flow switch alarm and the phase monitor alarm, cause the complete shut-down of the unit, and thus the freecooling function.

4.13 ON/OFF freecooling valve

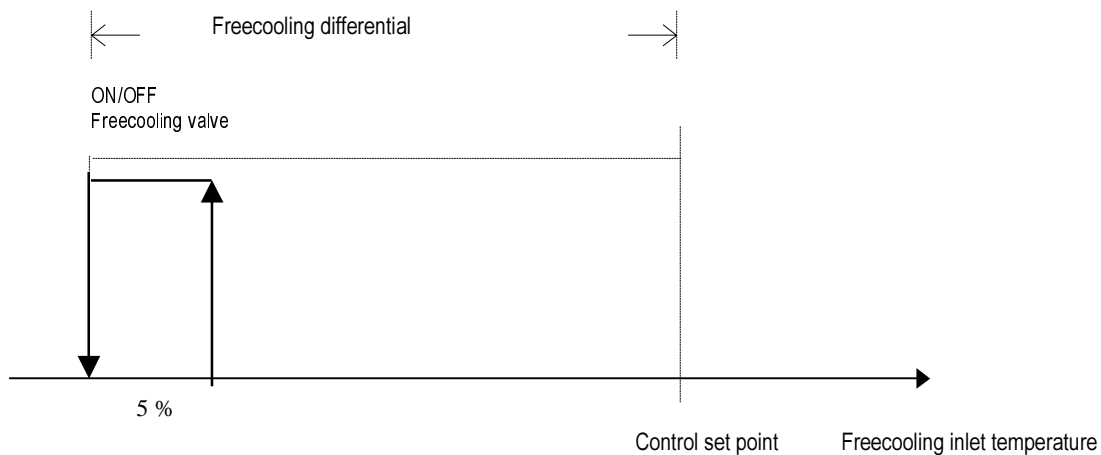

If the temperature conditions allow freecooling control, the ON/OFF freecooling valve will be activated as soon as to the temperature exceeds the activation threshold for the step in question by a temperature value equal to:

Control Set Point – Freecooling differential + 5.0 % Freecooling differential

The amplitude of the step is fixed at 5% of the Freecooling differential.

4.14 ON/OFF freecooling valve with stepped condenser control

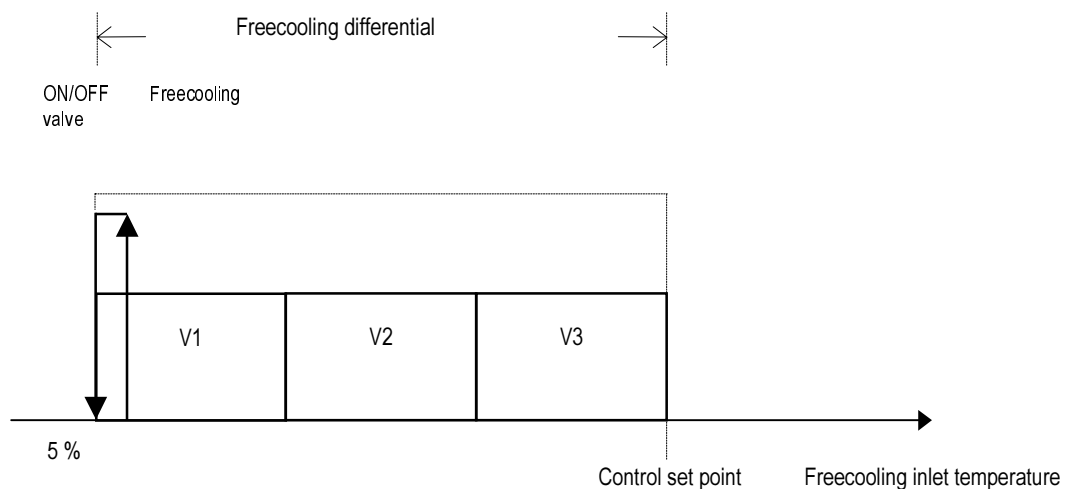

Example of freecooling control with ON/OFF valve and three condenser control steps.

The activation step of the ON/OFF valve will in any case be positioned in the first part of the control differential, and its amplitude will be 5% of the differential.

The activation steps of the condenser fans will be positioned proportionally inside the freecooling differential.

To calculate the amplitude of each step, use the following equation:

$$\text{Step amplitude} = \frac{\text{Freecooling differential}}{(\text{No. Master Fans} \times \text{Number Boards})}$$

It is assumed that all the circuits controlled by the different pCO boards making up the system are equivalent and the same number of devices are controlled.

4.15 ON/OFF freecooling valve with condenser inverter

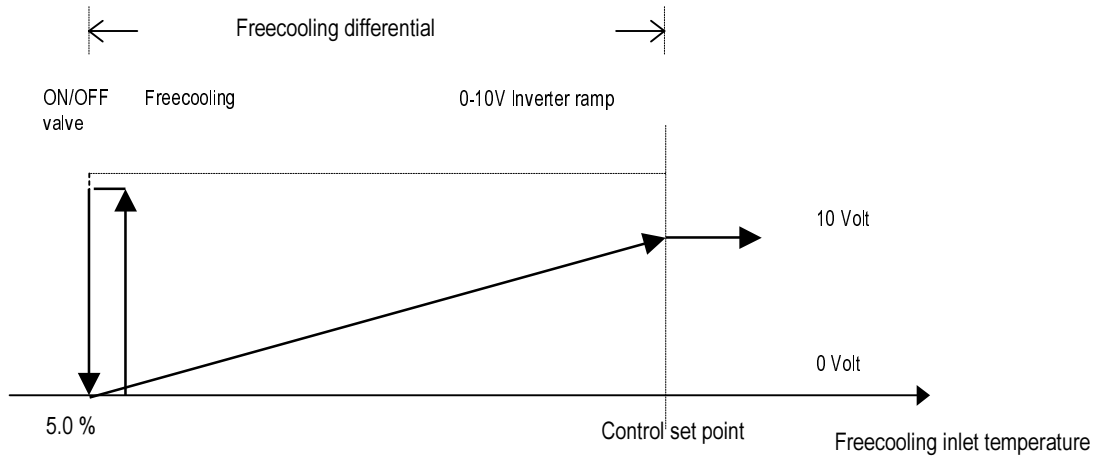

The activation step of the ON/OFF valve will in any case be positioned in the first part of the control differential, and its amplitude will be 5% of the differential.

The proportional ramp for the control of the condenser inverter analogue output will be calculated across the entire control differential; the 0-10 Volt value may be limited at the lower end based on the minimum output voltage value set on the screen.

All the proportional outputs relating to the different units making up the system are controlled in parallel.

4.16 0-10 Volt freecooling valve

The proportional control of the freecooling valve depends on whether stepped condenser control or a condenser inverter is used. Below are the control diagrams for both situations.

4.17 0-10 Volt freecooling valve with stepped condenser control

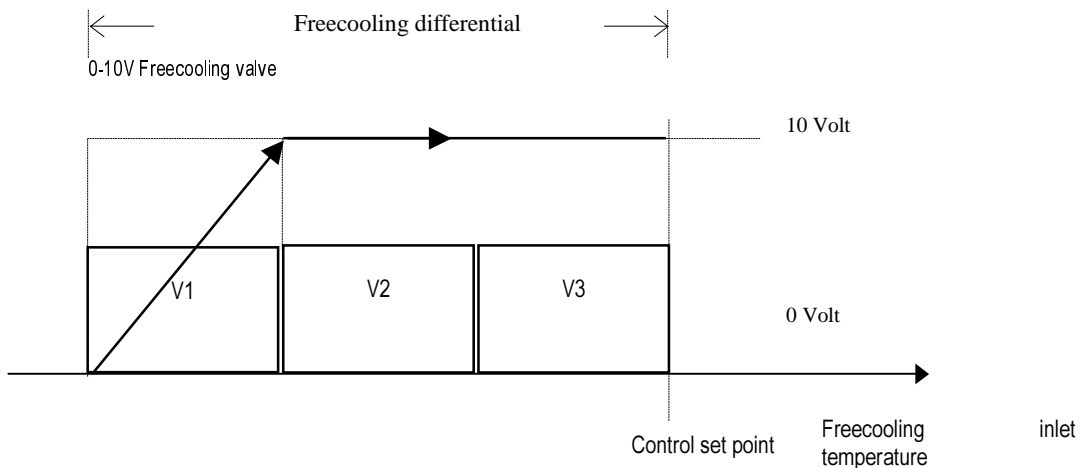

The freecooling valve proportional control ramp is calculated inside the first condenser fan activation step, in this way, when the first fan is started, the valve will be completely open, and thus there will be maximum water flow through the freecooling coil.

The activation steps of the condenser fans will be positioned proportionally inside the freecooling differential.

To calculate the amplitude of each step, use the following equation:

$$\text{Step amplitude} = \frac{\text{Freecooling differential}}{(\text{No. Master Fans} \times \text{Number Boards})}$$

It is assumed that all the circuits controlled by the different pCO boards making up the system are equivalent and the same number of devices are controlled.

4.18 0-10 Volt freecooling valve with condenser inverter

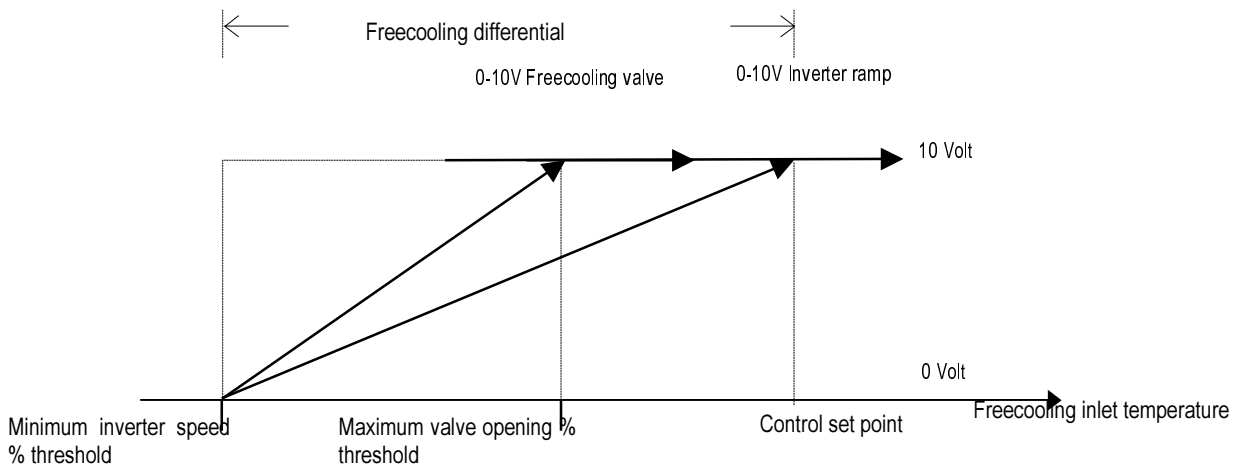

The freecooling valve proportional control ramp is calculated inside the area determined by the following thresholds:

Control set point – Freecooling differential

Control set point – Freecooling differential + Maximum valve opening % threshold

The condenser inverter proportional control ramp is calculated inside the area determined by the following thresholds:

Control set point – Freecooling differential + Minimum inverter speed % threshold

Control set point

The start/end points of the two control ramps can be modified as desired, by varying the threshold values (see graph), expressed as percentages of the set Freecooling differential.

For the Freecooling valve, the settings range from 25 to 100% of the differential.

For the condenser inverter, the settings range from 0 to 75% of the differential.

Example in reference to the graph

Control set point:	12.0°C
Freecooling differential:	4.0°C
Freecooling valve % threshold:	60%
Condenser inverter % threshold:	0%

Freecooling valve proportional control area =	8.0 - 10.4 °C
Control set point – Freecooling differential =	8.0°C
Maximum valve opening % threshold =	2.4°C

Condenser inverter proportional control area =	8.0 - 12.0 °C
Control set point – Freecooling differential =	8.0°C
Control set point – Freecooling differential + Minimum inverter speed % threshold =	12.0°C

5. Pump-Down

Inputs used

- on/off from keypad
- on/off from digital input
- on/off from supervisor
- low pressure switch

Parameters used

- enable pump-down
- maximum pump-down time

Outputs used

- compressors
- liquid solenoid

The pump-down function starts when:

1. the pCO unit is switched off from the supervisor, digital input and on/off button on the terminal. Note that the pCO slave units can be switched off individually, and so the pump-down function will be performed only on that unit. If the entire system is shut-down (from the master), all the compressors will run the pump-down function.
2. the compressors must be switched off by the temperature controller or, in general, due to no request (condensing units).

In both cases, the pump-down function ends due to low pressure and/or after the maximum time. See the screen and the graphs below for further information.

M_Manuf30

```

+-----+
|Pump down config. |
|Enable           N |
|Maximum time    000s|
+-----+

```

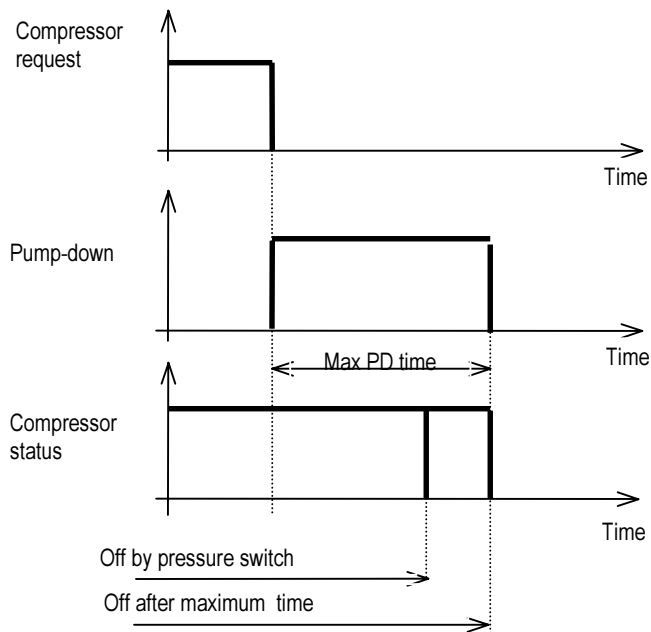

6. ALARMS

6.1 General description

The alarms are divided into three categories

Signal-only alarms (signal on the display and buzzer, signal on the display, buzzer, and alarm relay)

Circuit alarms (deactivate only the corresponding circuit, signal on the display, buzzer, alarm relay)

Serious alarms (deactivate the entire system, signal on the display, buzzer, alarm relay)

6.1.1 Signal-only alarms

- Unit maintenance alarm
- Compressor maintenance alarm
- Clock board fault or disconnected alarm
- Unit disconnected from network alarm

6.1.2 Circuit alarms

- High pressure /pressure switch alarm immediate shut-down of the compressor, with manual reset
- Low pressure alarm delayed at compressor start, immediate in stable conditions, with manual reset
- Compressor thermal overload alarm immediate shut-down of the compressor, with manual reset
- Oil differential alarm delay on acquisition, with manual reset
- Fan thermal overload alarm immediate shut-down of the fan, with manual reset

6.1.3 Serious alarms

- No water flow alarm
- Evaporator antifreeze alarm with manual reset
- Serious alarm from digital input
- Phase monitor alarm
- Pump thermal overload

6.1.4 Serious alarms

- no flow water alarm digital input delayed at start and in stable operation
- evaporator antifreeze alarm depending on the evaporator outlet probe, set point and differential for reset, manual reset
- serious alarm from digital input immediate shut-down of the unit, with manual reset

The alarms are reset by pressing the alarm button twice.

6.2 Logging the alarms

If the clock card, code PCOCLKMEM0 with 32K EEPROM is used, a log can be kept of the 1600 most recent alarm events.

For each alarm, the following data can be saved:

- Alarm code
- Date and time
- Control set point
- Control band
- Inlet temperature
- Outlet temperature

The log data is saved to the EEPROM of the card described above.

6.3 Table of alarms

Cod e	Alarm description	Compress ors OFF	Fans off	Pump off	System off	Reset Auto/Man	Delay	
AL01	Serious alarm	*	*	*	*	man	no	can be enabled from both master and slave
AL02	Antifreeze alarm	*	*		*	can be set	no	manual or automatic reset can be selected
AL03	Evaporator pump thermal overload	*	*	*	*	man	no	
AL04	Condenser pump thermal overload	*	*	*	*	man	no	
AL05	Evaporator flow switch	*	*		*	man	can be set	can be enabled from both master and slave
AL06	Condenser flow switch	*	*		*	man	can be set	
AL10	Low pressure switch.1	*Circuit 1				man	can be set	
AL11	Low pressure switch.2	*Circuit 2				man	can be set	
AL12	High pressure switch.1	*Circuit 1				man	no	
AL13	High pressure switch.2	*Circuit 2				man	no	
AL14	Oil differential pressure switch 1	*Circuit 1				man	can be set	
AL15	Oil differential pressure switch 2	*Circuit 2				man	can be set	
AL16	Compressor 1 thermal overload	*Comp. 1				man	no	
AL17	Compressor 2 thermal overload	*Comp. 2				man	no	
AL18	Compressor 3 thermal overload	*Comp. 3				man	no	Hermetic only
AL19	Compressor 4 thermal overload	*Comp. 4				man	no	Hermetic only
AL20	Fan 1 thermal overload		*			man	no	
AL21	Fan 2 thermal overload		*			man	no	
AL22	Fan 3 thermal overload		*			man	no	
AL23	High press. transducer 1	*Circuit 1	*			man	no	
AL24	High press. transducer 2	*Circuit 2	*			man	no	
AL30	Probe fault B1	*	*	*	*	auto.	60 sec.	
AL31	Probe fault B2	*	*	*	*	auto.	60 sec.	
AL32	Probe fault B3					auto.	60 sec.	
AL33	Probe fault B4					auto.	60 sec.	
AL34	Probe fault B5					auto.	60 sec.	
AL35	Probe fault B6					auto.	60 sec.	
AL36	Probe fault B7					auto.	60 sec.	
AL37	Probe fault B8					auto.	60 sec.	
AL40	Pump maintenance					man		
AL41	Compressor 1 maintenance					man..		
AL42	Compressor 2 maintenance					man.		
AL43	Compressor maintenance 3					man.		
AL44	Compressor maintenance 4					man.		
AL50	Unit 1 offline					auto.	30 sec.	
AL51	Unit 2 offline					auto.	30 sec.	
AL52	Unit 3 offline					auto.	30 sec.	
AL53	Unit 4 offline					auto.	30 sec.	
AL54	Evaporator fan thermal overload					man.		
AL55	32k clock card fault					man.		

7. pLAN network

All the devices connected to the pLAN network are identified by a specific address.

As terminals and pCO boards use the same type of address setting, terminals and pCO boards cannot have the same identifier.

In general, the addresses of the boards and terminals can be between 1 and 32.

For special applications, see the address settings shown in the paragraph "Setting the system addresses".

The address of the terminals is set using the dip-switches at the rear, while the pCO boards require the optional network card.

7.1 I/O board addresses

Optional network card (PCOADR0000 / PCOCLKMEM0)

There are two versions of the optional network card:

dip-switches and LEDs

Code: PCOADR0000

dip-switches, LEDs and clock-calendar

Code: PCOCLKMEM0

This card is required for the operation of the pCO boards in a local network.

Without this card, the unit cannot be controlled and there will be no exchange of information between the pCO boards installed

This card is essential for the operation of the software, even if only one pCO I/O board is used.

The following table shows the configuration of the dip-switches for pLAN addresses from 1 to 16.

Adr	Sw1	Sw2	Sw3	Sw4	Sw5
1	ON	Off	Off	off	off
2	off	ON	Off	off	off
3	ON	ON	Off	off	off
4	off	Off	ON	off	off
5	ON	Off	ON	off	off
6	off	ON	ON	off	off
7	ON	ON	ON	off	off
8	off	Off	Off	ON	off
9	ON	Off	Off	ON	off
10	off	ON	Off	ON	off
11	ON	ON	Off	ON	off
12	off	Off	ON	ON	off
13	ON	Off	ON	ON	off
14	off	ON	ON	ON	off
15	ON	ON	ON	ON	off
16	off	Off	Off	off	ON

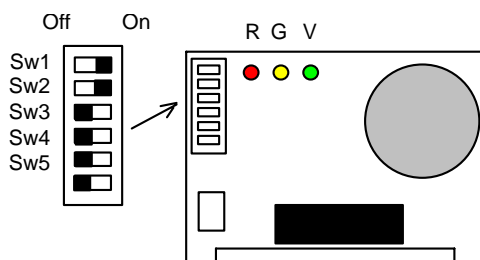

In the standard modular chiller application, EPSTD_MCHA, the addresses of the pCO units are:

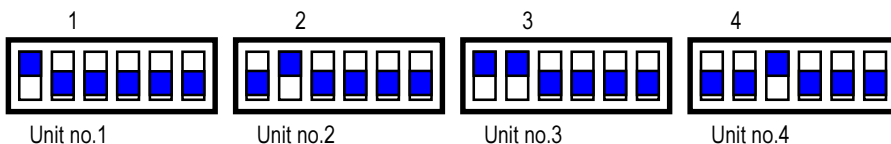

7.2 Terminal addresses

Terminal board, rear view

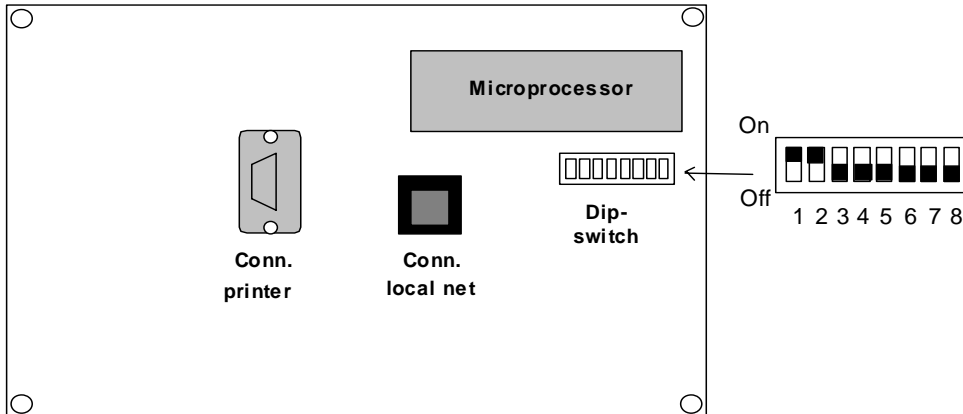

The address of the terminals is sets using the dip-switches at the rear.
 The address can be set in the range from 5-32, using dip-switches 1-6.
 The value of the address is derived as shown in the following table (also see the previous paragraph):

	Sw1		Sw2		Sw3		Sw4		Sw5		Sw5	
Status	OFF	ON	OFF	ON	OFF	ON	OFF	ON	OFF	ON	OFF	ON
P	0	1	0	2	0	16	0	8	0	16	0	32
Addr=P(Sw1)+P(Sw2)+P(Sw3)+P(Sw4)+P(Sw5)+P(Sw6)												

Unit terminal no.: 1,2,3,4.

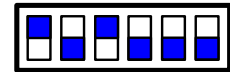

Dip-switches for address

The address of the shared terminal for the 4 pCO units must be greater or equal than 5

7.3 Terminal management

- Each pCO board, connected to the network, can manage more than 1 terminal (max 3). The display on these occurs simultaneously and not independently, like having the keypad and display connected in parallel.
- Each terminal associated to a specific board, can be *private* or *shared*.
Private a terminal is *private* if it only shows the output of one I/O board.
Shared a terminal is *shared* if, automatically or using the keypad, it can be switched between the output of more than one board.
- Each pCO constantly updates the display of the private terminals; shared terminals, on the other hand, are updated only if the pCO in question currently has the control. The following diagram is valid from a logical point of view:

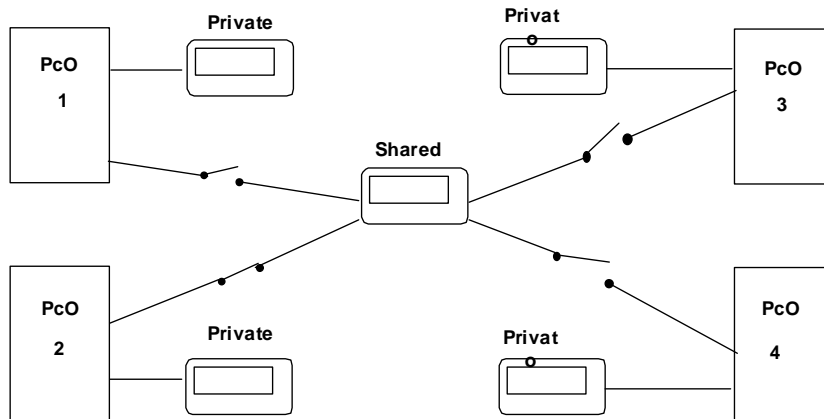

In this example the shared terminal is associated to 4 I/O boards yet, currently, only no. 2 can display data and receive the commands from the keypad.

- The switching between boards occurs in a cyclical sequence (1→2→3→4→1...), pressing the button (or combination of two buttons) that has been assigned this function
 The switching can also be handled automatically, upon direct request of the program. For example, an I/O board can request the control of the shared terminal to display alarms or, on the contrary, transfer possession to the following board at the end of a pre-set time (cyclical rotation)..

The number and the type of terminals is set during the initial configuration of the network. The relative data is saved in the EEPROM memory of each individual I/O board.

7.4 Terminal configuration procedure

The first operation to be performed, when starting a pLAN network for the first time or replacing an I/O board, is to activate the terminal configuration procedure.

- To start the procedure, check that the address of each pCO board and terminal is set correctly, as established during the design of the network.
It should be remembered that the address set is received only when the device is reset.
It is good practice to perform a global reset for the devices in the network in the event where, during configuration, more than one board has the same address.
- The configuration procedure must be run for each pCO board and must involve all the terminals in the network. The procedure can be started from any terminal, and this can also be temporarily connected for the purpose of performing the configuration operations, and then removed at the end of the procedure.
- The following operations must be performed:

7.4.1 Step 1: select the pCO board

- The procedure is activated by pressing buttons 0-1-2 together for at least 5 secs. (for compatibility, the buttons ▲ ▼ -Enter perform the same function):

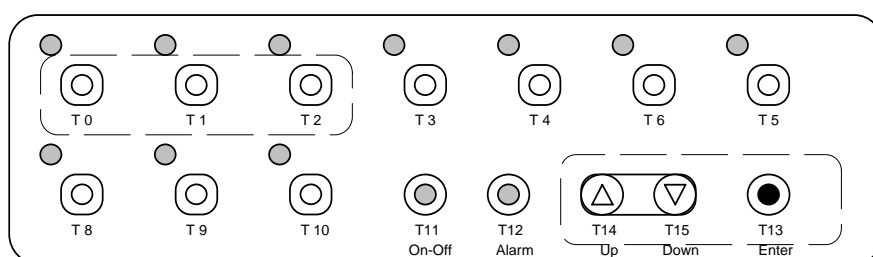

- If the display is an LCD, the following screen is displayed:

```
Terminal Adr: nn
I/O Board Adr: 12
```

- The field "Terminal Adr" always represents the address of the terminal being operated on.
- The field "I/O Board Adr" initially shows the address of the pCO board currently connected to the terminal.
If the terminal is not connected to any pCO board, the "—" is displayed.
Use the arrow buttons to modify the setting and force connection to a different pCO board.
The values displayed during the selection are the addresses of the pCO boards which are effectively connected to the network; if no pCO is active, the value "—" cannot be changed.
- Pressing the "Enter" button exits the first phase of the address setting procedure, and enters the actual terminal configuration screen.
- If the terminal remains inactive (no button is pressed) for more than 15 seconds, the configuration procedure is automatically ended.

7.4.2 Step 2: select associated terminals

For LCD displays, the screens displayed are:

```
Terminal Config
Press ENTER
to continue
```

Enter
↓

```
P:12  Adr      Priv/Shared
Trm1  02      Sh
Trm2  03      Pr
Trm3  None    --  Ok? No
```

- In this screen the "Enter" button moves the cursor from one field to the next, while the arrow buttons change the current value of the field.
The text P:00 indicates the address of the selected board; in the above example, it indicates that the I/O board with address 12 has been selected.
- To exit the configuration procedure and save the values, select the field "Ok ? No" and using the cursor buttons, bring up the message "Yes", then press "Enter".
To exit without saving, wait 30 secs without pressing any button.

7.4.3 Display terminal connection status

- If the terminal detects the inactivity of the pCO board being displayed, it cancels the display and then shows the message:

```
I/O Board xx fault
```

- If the terminal does not receive the network synchronisation message (token) for more than 10 seconds, it cancels the display and then shows the message:

```
NO LINK
```

In this situation, the green LED on the optional network card, installed on each pCO board, goes off.

7.4.4 Display network status: NetSTAT

The program includes a procedure, which can be activated only in the LCD version, for the real time display of the status and the type of currently connected peripherals.

This procedure is activated by pressing buttons 0-1-2 together (or alternatively Up-Down-Enter) for at least 10 seconds (after the first 5 seconds, the terminal configuration procedure is accessed). The following screen is displayed:

```
NetSTAT 1  0  0  1  1  - - - - 8
T: xx    9  - - - - - 1  - 16
Enter   17 - - - - - 24
To Exit 25 - - - - - 32
```

The number after the T indicates the address of the terminal that the procedure is being activated on, the symbols indicate the type of peripheral (terminal/pCO) and the corresponding address.

In the example, the network is made up of 2 pCO boards with addresses 1 and 2, and 3 terminals with addresses 3, 4, and 15.

8. User Interface

8.1 Table of Parameters

no	Description	level	Master / Slave	default	limits
	Manufacturer parameters				
1	Configuration (see tables of inputs/outputs)	Manufacturer	Mst/slv	16	0..23
2	Total number of compressors	Manufacturer	Mst/slv	1	1..8
3	Number of local compressors	Manufacturer	Mst/slv	1	1..4
4	Number of capacity stages per compressor	Manufacturer	Mst/slv	3	1..3
5	Enable serious, evaporator flow switch and condenser alarms	Manufacturer	Mst/slv	y	y/n
6	Enable probe B1	Manufacturer	Mst/slv	y	y/n
7	Enable probe B2	Manufacturer	Mst/slv	y	y/n
8	Enable probe B3	Manufacturer	Mst/slv	y	y/n
9	Enable probe B4	Manufacturer	Mst/slv	n	y/n
10	Enable probe B5	Manufacturer	Mst/slv	y	y/n
11	Enable probe B6	Manufacturer	Mst/slv	n	y/n
12	Enable probe B7	Manufacturer	Mst/slv	y	y/n
13	Enable probe B8	Manufacturer	Mst/slv	n	y/n
14	Start scale high pressure probes (4mA)	Manufacturer	Mst/slv	0	
15	Start scale low pressure probes (20mA)	Manufacturer	Mst/slv	30	
16	Enable tandem compressors	Manufacturer	Mst/slv	n	
17	Enable compressor rotation (FIFO logic)	Manufacturer	Mst	y	
18	Enable 32k clock card	Manufacturer	Mst/slv	n	
19	Enable Pump-down	Manufacturer	Mst/slv	n	
20	Maximum pump-down time	Manufacturer	Mst/slv	60	
21	Capacity control activation delay time	Manufacturer	Mst	1	
22	Capacity-control relay logic	Manufacturer	Mst	N.C.	
23	Minimum compressor on time	Manufacturer	Mst	60	0..9999
24	Minimum compressor off time	Manufacturer	Mst	360	0..9999
25	Time between starts of different compressors	Manufacturer	Mst	10	0..9999
26	Time between two starts of same compressor	Manufacturer	Mst	450	0..9999
27	Enable condenser control no pressure temperature	Manufacturer	Mst/slv	pressure	
28	Type of condenser control stepped inverter	Manufacturer	Mst/slv	inverter	
29	Number of condenser fans in the circuit	Manufacturer	Mst/slv	1	
30	Type of condenser single separate	Manufacturer	Mst/slv		
31	Condenser control set point	Manufacturer	Mst/slv	14	
32	Condenser control differential	Manufacturer	Mst/slv	2	
33	Voltage in volts at maximum inverter speed	Manufacturer	Mst/slv	10V	
34	Voltage in volts at minimum inverter speed	Manufacturer	Mst/slv	0V	
35	Inverter speed-up time	Manufacturer	Mst/slv	10	
36	Enable high pressure prevention threshold	Manufacturer	Mst/slv	y	
37	High pressure prevention set point	Manufacturer	Mst/slv	20	
38	High pressure prevention differential	Manufacturer	Mst/slv	2	
39	High pressure alarm set point	Manufacturer	Mst/slv	21	
40	High pressure alarm differential	Manufacturer	Mst/slv	2	
41	Low pressure alarm delay at start	Manufacturer	Mst/slv	40	
42	Low pressure alarm when stable	Manufacturer	Mst/slv	0	
44	Oil differential alarm delay at start	Manufacturer	Mst/slv	120	
45	Oil differential alarm delay when stable	Manufacturer	Mst/slv	10	
46	Antifreeze alarm set point	Manufacturer	Mst/slv	3	
47	Antifreeze alarm differential	Manufacturer	Mst/slv	1	
48	Antifreeze heater activation set point	Manufacturer	Mst/slv	5	
49	Antifreeze heater differential	Manufacturer	Mst/slv	1	
50	Evaporator flow switch alarm delay at start	Manufacturer	Mst	15	
51	Evaporator flow switch alarm delay when stable	Manufacturer	Mst	3	
52	Condenser flow switch alarm delay at start	Manufacturer	Mst	15	
53	Condenser flow switch alarm delay when stable	Manufacturer	Mst	3	
54	Type of freecooling valve on/off modulating 0/10 V.	Manufacturer	Mst	0/10V	
55	Reverse cycle valve logic	Manufacturer	Mst/slv	N.O.	
56	Defrost probe configuration pressure switches temperature pressure	Manufacturer	Mst/slv	temp.	
57	Global defrost configuration independent simultaneous separate	Manufacturer	Mst/slv	simult.	
58	Local defrost configuration simultaneous separate	Manufacturer	Mst/slv	simult.	
59	Set new manufacturer password	Manufacturer	Mst/slv	1234	

no	Description	level	Master / Slave	default	limits
60	pCO board ID number in pLAN network	manufacturer	Mst/slv	1	¼00
61	plan communication speed	manufacturer	Mst/slv	4	0/4
62	Select cooling / heating from supervisor	manufacturer	Mst/slv	n	y/n
63	On/Off from supervisor	manufacturer	Mst/slv	n	y/n
	User parameters				
64	Cooling set point upper limit	User	Mst	7	
65	Cooling set point lower limit	User	Mst	17	
66	Heating set point upper limit	User	Mst	40	
67	Heating set point lower limit	User	Mst	50	
68	Temperature control band	User	Mst	3	
69	Select control probe: water inlet (P/PI) water outlet (dead zone)	User	Mst	inlet	
70	Type of inlet control proportional proportional + integral	User	Mst	Prop.	
71	Integration time (for PI inlet control)	User	Mst	600	
72	Step activation time with outlet control	User	Mst	20	
73	Step deactivation time with outlet control	User	Mst	10	
74	Cooling threshold to force off steps with outlet control (chiller operation, avoid antifreeze alarm)	User	Mst	10	
75	Heating threshold to force off steps with outlet control (heat pump operation)	User	Mst	47	
76	Enable control with outside set point	User	Mst	n	
77	Minimum set point modification (0 Volt)	User	Mst	0	
78	Maximum set point modification (1 Volt)	User	Mst	5	
79	Minimum time between pump/fan activation and compressor start	User	Mst	5	
80	Pump/fan stop delay	User	Mst	5	
81	Enable on/off from digital input	User	Mst	n	
82	Enable cooling/heating from digital input	User	Mst	n	
83	Temperature delta for freecooling activation	User	Mst	2	
84	Temperature differential for fan control in freecooling	User	Mst	3	
85	Minimum time between defrosts	User	Mst/slv	1800	1.9999
86	Maximum defrost time	User	Mst/slv	300	1.9999
87	Start defrost threshold	User	Mst/slv	2	-99/99
88	End defrost threshold	User	Mst/slv	12	-99/99
89	Force compressors off at start and end defrost	User	Mst/slv	0	0/999
90	Reverse cycle delay	User	Mst/slv	10	0/999
91	Set new user password	User	Mst/slv	1234	
	Maintenance parameters				
92	Set compressor 1 maintenance hours	maintenance	Mst/slv	10000	0/99999
93	Set compressor 2 maintenance hours	maintenance	Mst/slv	10000	0/99999
94	Set compressor 3 maintenance hours	maintenance	Mst/slv	10000	0/99999
95	Set compressor 4 maintenance hours	maintenance	Mst/slv	10000	0/99999
96	Set unit maintenance hours	maintenance	Mst/slv	20000	0/99999
97	Enable filter for protection against electromagnetic disturbance	maintenance	Mst/slv	n	
98	Filter delay on analogue inputs	maintenance	Mst/slv	5	
99	Filter delay on digital inputs	maintenance	Mst/slv	1	
100	Probe calibration B1	maintenance	Mst/slv	0	-9/9
101	Probe calibration B2	maintenance	Mst/slv	0	-9/9
102	Probe calibration B3	maintenance	Mst/slv	0	-9/9
103	Probe calibration B4	maintenance	Mst/slv	0	-9/9
104	Probe calibration B5	maintenance	Mst/slv	0	-9/9
105	Probe calibration B6	maintenance	Mst/slv	0	-9/9
106	Probe calibration B7	maintenance	Mst/slv	0	-9/9
107	Probe calibration B8	maintenance	Mst/slv	0	-9/9
108	Enable compressor no.1	maintenance	Mst	y	
109	Enable compressor no.2	maintenance	Mst	y	
110	Enable compressor no.3	maintenance	Mst	y	
111	Enable compressor no.4	maintenance	Mst	y	
112	Enable compressor no.5	maintenance	Mst	y	
113	Enable compressor no.6	maintenance	Mst	y	
114	Enable compressor no.7	maintenance	Mst	y	
115	Enable compressor no.8	maintenance	Mst	y	
116	Set other maintenance password	maintenance	Mst/slv	1234	
	Set point parameters				
117	Cooling control set point	set point	Mst	12	
118	Heating control set point	set point	Mst	45	
119	Recovery control set point	set point	Mst	45	
120	Recovery control band	set point	Mst	3	
121	Priority Utility/Recovery	set point	Mst	utility	
	Clock parameters				
122	Control hours	clock	Mst/slv		0/23
123	Control minutes	clock	Mst/slv		0/59
124	Control day	clock	Mst/slv		0/31
125	Control month	clock	Mst/slv		0/12
126	Control year	clock	Mst/slv		0/99

8.2 Terminal keypad-display: front view

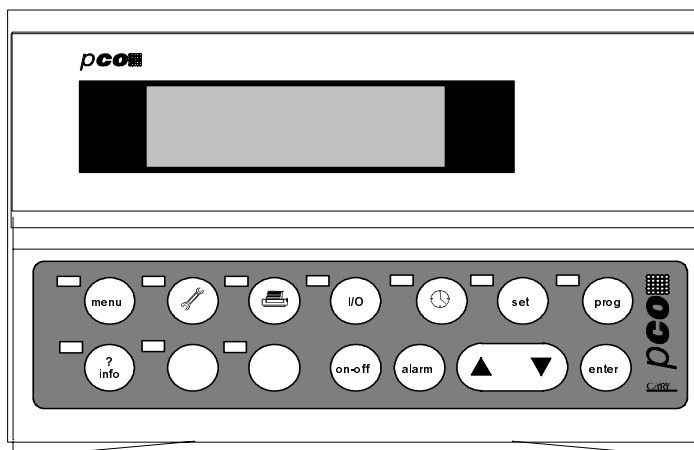

The figure below shows the *terminal* with the front door open.

It is fitted with a 4 row x 20 column LCD display, keypad and LEDs, and is managed by a microprocessor to allow the programming of the control parameters (setpoint, differential band, alarm thresholds) and basic operation by the user.

The terminal can be used to perform the following operations:

- the initial configuration of the machine
- the setting of the fundamental operating parameters when running
- the display and audible signal, by buzzer, of the alarm events.
- the display of all the values measured

The terminal and pCO board are connected using a 6-lead telephone cable.

The *terminal* does not have to be connected to the *main board* for the normal operation of the controller.

8.3 Using the buttons

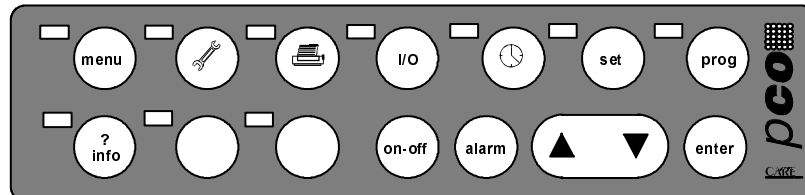

 *Accesses the screen that displays the main values and machine status*

 *Accesses the values corresponding to the maintenance of the devices (operating hours of the device and reset hour counter, alarm log, manual operation procedure)*

 *Not featured*

 *Accesses the screen that displays the status of the digital and analogue inputs and outputs*

 *Accesses the screen for setting the clock (if the clock card is fitted)*

 **set**
 Accesses the screen for displaying/setting the control set point

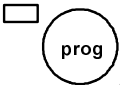
 **prog**
 Accesses the screens for setting the user parameters (thresholds, delays etc..)

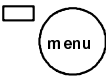
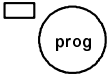
 **menu** +  **prog**
 Pressing these buttons at the same time enters the machine configuration mode (number of devices connected to the pCO, setting the end scale, etc..)

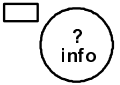
 **? info**
 Switches the control of the terminal from one pCO board to another.

8.4 LEDs

The LEDs to the side of each button light up when the corresponding function is activated.



Figure 1

References Fig. 1

1. on/off button: switches the unit on and off. The green LED that on the button indicates the status of the unit
2. alarm button: used to display and manually reset the alarms and to silence the buzzer. If the button is on (red), at least one alarm has been activated.
 Pressing the button once silences the buzzer and displays the screen corresponding to the active alarm.
 Pressing it a second time resets the alarm signal.
3. up arrow: used to set the values of the control parameters and move between the screens(not back-lit).
4. down arrow: used to set the values of the control parameters and move between the screens (not back-lit).
5. enter button: used to move the cursor inside the screens and to save the values of the set parameters. The button is constantly back-lit (yellow) to indicate that the unit is powered.

8.5 Display

A 4 row x 20 column LCD display is used.

The values and the information relating to the operation of the unit are shown on specific screens.

To move around the screens, use the buttons on the terminal, as follows:

8.5.1 Moving inside the screens

```

+-----+
|x      Riga0
|Home   Riga1
|       Riga2
|       Riga3
+-----+
    
```

If the cursor is in the top left corner (Home), pressing the UP/DOWN buttons accesses the following screens in the selected branch. If the screen contains fields for setting values, then pressing the ENTER button moves the cursor to these fields. In the field the values can be set, within the allowed limits, by pressing the UP/DOWN buttons. Once the desired value has been entered, press the ENTER button again to save the value.

9. Supervisor

The following is a list of the variables that are managed by the supervisor.

Direction	Type	Index	Variable name	Description
OUT	D	1	SYSON_S	Unit On/Off. On the master starts all the connected units. On each single slave, enables the unit to start.
OUT	D	10	DOUT_1	Digital output 1
OUT	D	11	DOUT_2	Digital output 2
OUT	D	12	DOUT_3	Digital output 3
OUT	D	13	DOUT_4	Digital output 4
OUT	D	14	DOUT_5	Digital output 5
OUT	D	15	DOUT_6	Digital output 6
OUT	D	16	DOUT_7	Digital output 7
OUT	D	17	DOUT_8	Digital output 8
OUT	D	18	DOUT_9	Digital output 9
OUT	D	19	DOUT_10	Digital output 10
OUT	D	20	DOUT_11	Digital output 11
OUT	D	21	DOUT_12	Digital output 12
OUT	D	22	DOUT_13	Digital output 13
OUT	D	28	master	Indicates if the unit is the MASTER
OUT	D	29	slave	Indicates if the unit is a SLAVE
OUT	D	40	Main_Pump	Main pump (or Main fan)
OUT	D	41	Cond_Pump	Condenser pump
IN/OUT	D	42	SuperV_OnOff	On/Off from supervisor
IN/OUT	D	44	Sum_Win_Sup	Select chiller/HP mode from supervisor
OUT	D	46	En_Freecooling	Enable freecooling based on configuration
OUT	D	47	En_AA_Unit	AIR/AIR unit selected: 0=Main_Pump, 1=Main_Fun
OUT	D	48	En_WW_Unit	WATER/WATER unit selected: enable condenser pump
OUT	D	49	Sum_Win_Sel	Digital input for selecting chiller / HP mode
OUT	D	50	En_Sum_Win	Enable digital input for selecting chiller / HP mode
OUT	D	51	Cooling_Heating	Operating mode: 0=chiller, 1=heat pump
IN/OUT	D	53	Cond_Config	Select type of condenser: 0=single, 1=double
IN/OUT	D	56	Inverter_Steps	Select operation, inverter or stepped: 0 = inverter; 1 = stepped
OUT	D	57	Inverter	Operating mode selected: 1 = inverter; 0 = stepped
IN/OUT	D	58	FC_Valve_Type	Select type of freecooling valve: On / Off
OUT	D	59	Not_FC_Vlv_Type	Select type of freecooling valve: 0 / 10V
IN/OUT	D	60	Unloads_Logic	Select capacity control logic: 0=normally closed, 1=normally open
IN/OUT	D	61	Valve4way_Logic	Select 4-way valve logic: 0=normally closed, 1=normally open
IN/OUT	D	30	En_B1	Enable probe B1
IN/OUT	D	31	En_B2	Enable probe B2
IN/OUT	D	32	En_B3	Enable probe B3
IN/OUT	D	33	En_B4	Enable probe B4
IN/OUT	D	34	En_B5	Enable probe B5
IN/OUT	D	35	En_B6	Enable probe B6
IN/OUT	D	36	En_B7	Enable probe B7
IN/OUT	D	37	En_B8	Enable probe B8
OUT	D	70	GLB_AL	General alarm
OUT	D	71	MAN_FREEZE	Antifreeze alarm
OUT	D	72	mAL_OV1	Compressor 1 thermal overload
OUT	D	73	mAL_OV2	Compressor 2 thermal overload
OUT	D	74	mAL_OV3	Compressor 3 thermal overload
OUT	D	75	mAL_OV4	Compressor 4 thermal overload
OUT	D	76	mAL_CFLOW	Condenser flow switch alarm
OUT	D	77	mAL_EFLOW	Evaporator flow switch alarm
OUT	D	78	mAL_HP1	High pressure alarm circuit 1 (pressure switch)
OUT	D	79	mAL_HP2	High pressure alarm circuit 2 (pressure switch)
OUT	D	80	mAL_OD1	Oil differential alarm circuit 1
OUT	D	81	mAL_OD2	Oil differential alarm circuit 2
OUT	D	82	mAL_LP1	Low pressure alarm circuit 1
OUT	D	83	mAL_LP2	Low pressure alarm circuit 2
OUT	D	84	mAL_HPT1	High pressure transducer alarm 1
OUT	D	85	mAL_HPT2	High pressure transducer alarm 2
OUT	D	86	mAL_SERIOUS	Serious alarm from digital input
OUT	D	87	mAL_F1_OVERLOAD	Condenser fan 1 thermal overload alarm
OUT	D	88	mAL_F2_OVERLOAD	Condenser fan 2 thermal overload alarm
OUT	D	89	mAL_F3_OVERLOAD	Condenser fan 3 thermal overload alarm
OUT	D	90	mAL_FAN	Main fan thermal overload alarm
OUT	D	91	mAL_CPUMP	Condenser pump thermal overload alarm
OUT	D	92	mAL_PUMP	Evaporator pump thermal overload alarm
OUT	D	93	mAL_UNIT1_OFFL	Unit 1 disconnected alarm
OUT	D	94	mAL_UNIT2_OFFL	Unit 2 disconnected alarm
OUT	D	95	mAL_UNIT3_OFFL	Unit 3 disconnected alarm
OUT	D	96	mAL_UNIT4_OFFL	Unit 4 disconnected alarm
OUT	D	97	mAL_B1	Probe B1 broken or disconnected alarm
OUT	D	98	mAL_B2	Probe B2 broken or disconnected alarm
OUT	D	99	mAL_B3	Probe B3 broken or disconnected alarm
OUT	D	100	mAL_B4	Probe B4 broken or disconnected alarm
OUT	D	101	mAL_B5	Probe B5 broken or disconnected alarm
OUT	D	102	mAL_B6	Probe B6 broken or disconnected alarm
OUT	D	103	mAL_B7	Probe B7 broken or disconnected alarm
OUT	D	104	mAL_B8	Probe B8 broken or disconnected alarm
OUT	D	105	mAL_H_MAIN_PUMP	Main pump or main fan maintenance alarm
OUT	D	106	mAL_H_COMP1	Compressor 1 maintenance alarm
OUT	D	107	mAL_H_COMP2	Compressor 2 maintenance alarm
OUT	D	108	mAL_H_COMP3	Compressor 3 maintenance alarm
OUT	D	109	mAL_H_COMP4	Compressor 4 maintenance alarm
OUT	D	110	mAL_CLOCK32	32k clock card broken or not connected alarm

Direction	Type	Index	Variable name	Description
OUT	A	1	AIN_1	Analogue input 1
OUT	A	2	AIN_2	Analogue input 2
OUT	A	3	AIN_3	Analogue input 3
OUT	A	4	AIN_4	Analogue input 4
OUT	A	5	AIN_5	Analogue input 5
OUT	A	6	AIN_6	Analogue input 6
OUT	A	7	AIN_7	Analogue input 7
OUT	A	8	AIN_8	Analogue input 8
OUT	A	9	Analog_Out_1	Analogue output 1
OUT	A	10	Analog_Out_2	Analogue output 2
IN/OUT	A	11	S_Temp_Setpoint	Cooling set point (evaporator set point)
IN/OUT	A	12	W_Temp_Setpoint	Heating set point (condenser set point)
IN/OUT	A	13	Cond_Setpoint	Condenser control set point
OUT	A	14	In_Temp_Setp	Current set point

Direction	Type	Index	Variable name	Description
OUT	I	1		STeFA supervisor
OUT	I	2		STeFA supervisor
OUT	I	3		STeFA supervisor
OUT	I	4		STeFA supervisor
OUT	I	5		STeFA supervisor
OUT	I	6		STeFA supervisor
OUT	I	7		STeFA supervisor
OUT	I	8		STeFA supervisor
OUT	I	9		STeFA supervisor
OUT	I	10	CU_Remote_Ctrl	Compressor remote control
OUT	I	11	Recover_Mode	Recovery mode: 1 = recovery-only 2 = chiller 3 = chiller + recovery 4 = defrost 5 = recovery-only 6 = heat pump
OUT	I	12	Unit_Status	Unit status: 0 = unit active 1 = off from alarm 2 = off from supervisor 3 = off from time bands 4 = off from digital input (DIN3) 5 = off local (keypad on terminal) 6 = manual operation
IN/OUT	I	13	Cond_Fans_Mng	Fan control: 0 = none 1 = pressure 2 = temperature
OUT	I	20	X_H_Main_Pump	Main pump operating hour count (high byte)
OUT	I	21	X_L_Main_Pump	Main pump operating hour count (low byte)
OUT	I	22	X_H_Comp1	Compressor 1 operating hour count (high byte)
OUT	I	23	X_L_Comp1	Compressor 1 operating hour count (low byte)
OUT	I	24	X_H_Comp2	Compressor 2 operating hour count (high byte)
OUT	I	25	X_L_Comp2	Compressor 2 operating hour count (low byte)
OUT	I	26	X_H_Comp3	Compressor 3 operating hour count (high byte)
OUT	I	27	X_L_Comp3	Compressor 3 operating hour count (low byte)
OUT	I	28	X_H_Comp4	Compressor 4 operating hour count (high byte)
OUT	I	29	X_L_Comp4	Compressor 3 operating hour count (low byte)
OUT	I	30	Config_Unit	Device configuration for all units: 0 = CCCC 1 = CPCP 2 = CPPP [C = compressor; P = capacity stage]
IN/OUT	I	31	Config_Type	Select unit type: 0 - 23 (see manual)
OUT	I	32	Ph_Circ_Type	Type of circuit (physical) = 0 = water / air 1 = air /air 2 = water / water
IN/OUT	I	33	N_Comps	Total number of compressors on the machine
IN/OUT	I	34	Comps_x_Unit	Number of compressors per unit (same for all units)
IN/OUT	I	35	N_Unloaders	Number of capacity stages per compressor (same for all units)
IN/OUT	I	36	Cond_Fans	Number of condenser fans (1-3 with single condenser, 1-2 with double condenser)
OUT	I	37	Fan1_Speed_Reg	Inverter speed circuit 1
OUT	I	38	Fan2_Speed_Reg	Inverter speed circuit 2
OUT	I	39	Freecool_Valve	Freecooling valve opening

DIRECTION**TYPE:**

IN: Supervisor--> pCO **D:** Digital
OUT: Supervisor<-- pCO **I:** Integer
IN/OUT: Supervisor<-> pCO **A:** Analogue

10. List of screens

10.1.1 Menu button

```
M_MainMask
+-----+
| 00 00      00 00 00 |
|                00.0 |
|                00.0 |
| U:00 DEFROST |
+-----+
```

10.1.2 Set button

```
M_Setpoint5
+-----+
| Summer setpoint |
|                |
|                00.0°C |
| Winter setpoint |
|                |
|                00.0°C |
+-----+
```

```
M_Setpoint10
+-----+
| Actual setpoint |
|                |
|                00.0°C |
+-----+
```

```
M_Setpoint15
+-----+
| Recover |
| Priority EVAPORATOR |
| Setpoint 00.0°C |
| Diff. 00.0°C |
+-----+
```

10.1.3 I/O button

```
M_InOut5
+-----+
| CAREL srl |
| Brugine (PD) Italy |
| CODE: EPSTDMCHA |
| Ver.4.112 13/02/2002 |
+-----+
```

```
M_InOut10
+-----+
| Digital inputs U: |
| CCCCCCCCCCC |
| Digital outputs |
| OOOOOOOOOOOO |
+-----+
```

```
M_InOut15
+-----+
| Analog inputs: U: |
| B1: 00.0°C |
| B2: 00.0°C |
+-----+
```

```
M_InOut20
+-----+
| Analog inputs: U: |
| B3: 00.0°C |
| B4: 00.0°C |
+-----+
```

```
M_InOut25
+-----+
| Analog inputs: U: |
| B5: 0000°C |
| B6: 00.0°C |
+-----+
```

```
M_InOut30
+-----+
| Analog inputs: U: |
| B7: 00.0bar |
| B8: 00.0bar |
+-----+
```

```
M_InOut35
+-----+
| Analog outputs U: |
| Y0: 00.0V |
| Y1: 00.0V |
+-----+
```

10.1.4 Menu+Prog button

```
M_Pw_User
+-----+
| Insert |
| user password |
|                |
|                0000 |
+-----+
```

```
M_Manuf5
+-----+
| Unit config. 00 |
| WATER/AIR |
| CHILLER |
| SEMIERMETICS COMPS. |
+-----+
```

```
m_manuf07
+-----+
| Evap./Condensator |
| flow alarm and |
| serious alarm |
| Enable N |
+-----+
```

```
M_Manuf10
+-----+
| Probes enable U: |
| B1: N B2: N B3: N |
| B4: N B5: N B6: N |
| B7: N B8: N |
+-----+
```

```
M_Manuf12
+-----+
| Input type |
| Analog B5 0-1V |
+-----+
```

```
M_Manuf15
+-----+
| Pressure probe |
| configuration |
| 4mA 000.0bar |
| 20mA 000.0bar |
+-----+
```

```
M_Manuf20
+-----+
| Compressors config. |
| Total comp. n. 00 |
| Local comp. n. 0 |
| Unloads per comp. 0 |
+-----+
```

```
M_Manuf25
+-----+
| Compressors config. |
| PW time 000-ms |
| N |
+-----+
```

```
M_Manuf27
+-----+
| Clock board 32k |
| Enable N |
+-----+
```

```
M_Manuf30
+-----+
| Pump down config. |
| Enable N |
| Maximum time 000s |
+-----+
```

```
M_Manuf35
+-----+
| Unloaders config. |
| Delay time 00s |
| Logic N.C. |
+-----+
```

```
M_Manuf40
+-----+
| Minimum compressors |
| power-on time 0000s |
| Minimum compressors |
| power-off time 0000s |
+-----+
```

```
M_Manuf45
+-----+
| Min time betw. diff. |
| comp start 0000s |
| Min time betw. same |
| comp starts 0000s |
+-----+
```

```
M_Manuf50
+-----+
| Condensation |
| Enable NONE |
| Type INV. |
+-----+
```

```
M_Manuf55
+-----+
| Condensation |
| Condensator SINGLE |
| N.Fans 0 |
+-----+
```

```
M_Manuf60
+-----+
| Condensation |
| Setpoint 000.0--- |
| Diff. 000.0--- |
+-----+
```

```
M_Manuf70
+-----+
| Inverter |
| Max.speed 00.0V |
| Min.speed 00.0V |
| Speed up time 000s |
+-----+
```

```
M_Manuf80
+-----+
| Prevent enable N |
| Probe PRESSURE |
| Setpoint 00.0--- |
| Diff. 00.0--- |
+-----+
```

```
M_Manuf82
+-----+
| Prevent |
| Unloads switching on |
| delay 00s |
| Exit delay 000s |
+-----+
```

```
M_Manuf85
+-----+
| Transducers high |
| pressure alarm |
| Setpoint 00.0bar |
| Diff. 00.0bar |
+-----+
```

```
M_Manuf90
+-----+
| Low pressure alarm |
| Startup delay 000s |
| Run delay 000s |
+-----+
```

```
M_Manuf95
+-----+
| Differential |
| oil alarm |
| Startup delay 000s |
| Run delay 000s |
+-----+
```

```
M_Manuf100
+-----+
| Antifreeze alarm |
| Setpoint 00.0°C |
| Diff. 00.0°C |
+-----+
```

```
M_Manuf102
+-----+
| Antifreeze alarm |
| Reset MANUAL |
| Delay 000min |
+-----+
```

```
M_Manuf105
+-----+
| Antifreeze heater |
| Setpoint 00.0°C |
| Diff. 00.0°C |
+-----+
```

```
M_Manuf110
+-----+
| Evaporator |
| flow alarm |
| Startup delay 000s |
| Run delay 000s |
+-----+
```

```
M_Manuf115
+-----+
| Condensator |
| flow alarm |
| Startup delay 000s |
| Run delay 000s |
+-----+
```

```
M_Manuf120
+-----+
| Freecooling config. |
| Valve type 0/10V |
+-----+
```

```
M_Manuf125
+-----+
| Reversing valve |
| logic N.C. |
+-----+
```

```
M_Manuf130
+-----+
| Defrost config. |
| Probe TEMPERATURE |
| Global SIMULTANEOUS |
| Local SIMULTANEOUS |
+-----+
```

```
m_manuf131
+-----+
| Remote compressors |
| control management |
| Type STEPS |
+-----+
```

```
M_Manuf132
+-----+
| Supervisory System |
| Communication speed: |
| 1200 (RS485/RS422) |
| Identificat.No.: 000 |
+-----+
```

```
M_Manuf135
+-----+
| Reset all parameters |
| to default values N |
+-----+
```

```
M_Manuf190
+-----+
| Insert another |
| manufacturer |
| password 0000 |
+-----+
```

10.1.5 Prog button

```
M_Pw_User
+-----+
| Insert |
| user password |
|                |
|                0000 |
+-----+
```

```
M_User0
+-----+
| Measurement unit for |
| Pressure bar |
| Temperature °C |
+-----+
```

```
M_User5
+-----+
| Summer temperature |
| setpoint limits |
| Low 00.0°C |
| High 00.0°C |
+-----+
```



```
M_User15
+-----+
|Winter temperature|
|setpoint limits  |
|Low      00.0EC  |
|High     00.0EC  |
+-----+
```

```
M_User17
+-----+
|Regulation       |
|temperature type |
|Type            INLET|
+-----+
```

```
M_User20
+-----+
|Inlet regulation |
|                |
|Type            PROP|
|Integration t.  0000s|
+-----+
```

```
M_User22
+-----+
|Outlet regulation|
|                |
|Time on         0000s|
|Time off        0000s|
+-----+
```

```
M_User23
+-----+
|Outlet regulation|
|force off       |
|Summer         00.0EC|
|Winter         00.0EC|
+-----+
```

```
M_User24
+-----+
|External setpoint|
|Enable          N  |
|Min.           00.0EC|
|Max.           00.0EC|
+-----+
```

```
M_User25
+-----+
|Regulation temp. |
|band             00.0EC|
+-----+
```

```
M_User30
+-----+
|Time between main|
|pump/fan and comp.|
|start           000s|
+-----+
```

```
M_User35
+-----+
|Delay on switching|
|the main pump off |
|                000s|
+-----+
```

```
M_User40
+-----+
|Digital input remote|
|on / off           N |
|Digital input remote|
|Summer / Winter   N |
+-----+
```

```
M_User42
+-----+
|Supervisory remote |
|on / off           N |
|Supervisory remote |
|Summer / Winter   N |
+-----+
```

```
M_User45
+-----+
|Freecooling       |
|parameters       |
|Delta            00.0EC|
|Diff.            00.0EC|
+-----+
```

```
M_User46
+-----+
|Freecooling max.vlv|
|open threshold 000%|
|Freecooling min.inv|
|start threshold 000%|
+-----+
```

```
M_User50
+-----+
|Defrost parameters|
|Start            00.0EC|
|Stop             00.0EC|
+-----+
```

```
M_User55
+-----+
|Defrost parameters|
|Delay time       00000s|
|Maximum time     00000s|
+-----+
```

```
M_User100
+-----+
|Defrost parameters|
|Switch compressor |
|off when defrost  |
|begins/ends for 000s|
+-----+
```

```
M_User101
+-----+
|Defrost parameters|
|Reversing cycle  |
|delay           000s|
+-----+
```

```
M_User60
+-----+
|Insert another   |
|user password   |
|                0000|
+-----+
```

10.1.6 Maintenance button

```
M_Maint5
+-----+
|Main pump/fan    U: |
|hour meter      |
|Hours           000000|
+-----+
```

```
M_Maint10
+-----+
|Hour meters     U: |
|Compressor 1   000000|
|Compressor 2   000000|
+-----+
```

```
M_Maint15
+-----+
|Hour meters     U: |
|Compressor 3   000000|
|Compressor 4   000000|
+-----+
```

```
M_Maint17
+-----+
|History alarm   0000|
|AL000 00:00 00/00/00|
|Set 00.0 Band 00.0|
|T.In 00.0 T.Out 00.0|
+-----+
```

```
M_Pw_Maint
+-----+
|Insert         |
|maintenance password|
|                0000|
+-----+
```

```
M_Maint20
+-----+
|Main pump/fan    U: |
|hour meter      |
|Threshold        000x1000|
|Req.reset       N 000000|
+-----+
```

```
M_Maint25
+-----+
|Compressor 1    U: |
|hour meter      |
|Threshold        000x1000|
|Req.reset       N 000000|
+-----+
```

```
M_Maint30
+-----+
|Compressor 2    U: |
|hour meter      |
|Threshold        000x1000|
|Req.reset       N 000000|
+-----+
```

```
M_Maint35
+-----+
|Compressor 3    U: |
|hour meter      |
|Threshold        000x1000|
|Req.reset       N 000000|
+-----+
```

```
M_Maint40
+-----+
|Compressor 4    U: |
|hour meter      |
|Threshold        000x1000|
|Req.reset       N 000000|
+-----+
```

```
M_Maint45
+-----+
|Filters config. U: |
|Enable          N  |
|Anal.delay time 0s  |
|Dig.delay time  0s  |
+-----+
```

```
M_Maint50
+-----+
|Inputs probes   U: |
|offset         |
|B1: 0.0 B2: 0.0 |
|B3: 0.0 B4: 0.0 |
+-----+
```

```
M_Maint55
+-----+
|Inputs probes   U: |
|offset         |
|B5: 0.0 B6: 0.0 |
|B7: 0.0 B8: 0.0 |
+-----+
```

```
M_Maint60
+-----+
|Compressors enable|
|C1:N C2:N C3:N C4:N|
|C5:N C6:N C7:N C8:N|
+-----+
```

```
M_Maint75
+-----+
|Erase historical |
|memory board     N  |
+-----+
```

```
M_Maint100
+-----+
|Insert another   |
|maintenance     |
|password        0000|
+-----+
```

10.1.7 Printer button

```
M_Printer5
+-----+
|Printer not     |
|available       |
+-----+
```

10.1.8 Clock button

```
M_Clock5
+-----+
|Clock not      |
|installed      |
+-----+
```

```
M_Clock10
+-----+
|Clock config.  |
|Time          00:00|
|Date          00/00/00|
+-----+
```

10.1.9 Alarm button

```
M_Alarm0
+-----+
|No alarms     |
|detected      |
+-----+
```

```
M_Alarm5
+-----+
|AL:002        U: |
|Freeze alarm  |
+-----+
```

```
M_Alarm10
+-----+
|AL:016        U: |
|Compressor 1  |
|overload      |
+-----+
```

```
M_Alarm15
+-----+
|AL:017        U: |
|Compressor 2  |
|overload      |
+-----+
```

```
M_Alarm20
+-----+
|AL:018        U: |
|Compressor 3  |
|overload      |
+-----+
```

```
M_Alarm25
+-----+
|AL:019        U: |
|Compressor 4  |
|overload      |
+-----+
```

```
M_Alarm30
+-----+
|AL:005        U: |
|Evaporator flow|
|alarm          |
+-----+
```

```
M_Alarm35
+-----+
|AL:006        U: |
|Condensator flow|
|alarm          |
+-----+
```

```
M_Alarm40
+-----+
|AL:012        U: |
|High pressure  |
|circuit 1     |
|(pressostat)  |
+-----+
```

M_Alarm45 +-----+ AL:013 U: High pressure circuit 2 (pressostat) +-----+	M_Alarm85 +-----+ AL:020 U: Condensator fan n.1 overload +-----+	M_Alarm120 +-----+ AL:052 U: Unit n.3 is offline +-----+	M_Alarm160 +-----+ AL:036 U: B7 probe fault or not connected +-----+
M_Alarm50 +-----+ AL:014 U: Oil differential alarm circuit 1 +-----+	M_Alarm90 +-----+ AL:021 U: Condensator fan n.2 overload +-----+	M_Alarm125 +-----+ AL:053 U: Unit n.4 is offline +-----+	M_Alarm165 +-----+ AL:037 U: B8 probe fault or not connected +-----+
M_Alarm55 +-----+ AL:015 U: Oil differential alarm circuit 2 +-----+	M_Alarm95 +-----+ AL:022 U: Condensator fan n.3 overload +-----+	M_Alarm130 +-----+ AL:030 U: B1 probe fault or not connected +-----+	M_Alarm170 +-----+ AL:040 U: Main fan/pump maintenance +-----+
M_Alarm60 +-----+ AL:010 U: Low pressure alarm circuit 1 +-----+	M_Alarm100 +-----+ AL:054 U: Main fan overload +-----+	M_Alarm135 +-----+ AL:031 U: B2 probe fault or not connected +-----+	M_Alarm175 +-----+ AL:041 U: Compressor 1 maintenance +-----+
M_Alarm65 +-----+ AL:011 U: Low pressure alarm circuit 2 +-----+	M_Alarm103 +-----+ AL:004 U: Condensator pump overload +-----+	M_Alarm140 +-----+ AL:032 U: B3 probe fault or not connected +-----+	M_Alarm180 +-----+ AL:042 U: Compressor 2 maintenance +-----+
M_Alarm70 +-----+ AL:023 U: Transducer 1 high pressure alarm +-----+	M_Alarm105 +-----+ AL:003 U: Evaporator pump overload +-----+	M_Alarm145 +-----+ AL:033 U: B4 probe fault or not connected +-----+	M_Alarm185 +-----+ AL:043 U: Compressor 3 maintenance +-----+
M_Alarm75 +-----+ AL:024 U: Transducer 2 high pressure alarm +-----+	M_Alarm110 +-----+ AL:050 U: Unit n.1 is offline +-----+	M_Alarm150 +-----+ AL:034 U: B5 probe fault or not connected +-----+	M_Alarm190 +-----+ AL:044 U: Compressor 4 maintenance +-----+
M_Alarm80 +-----+ AL:001 U: Serious alarm by digital input +-----+	M_Alarm115 +-----+ AL:051 U: Unit n.2 is offline +-----+	M_Alarm155 +-----+ AL:035 U: B6 probe fault or not connected +-----+	M_Alarm195 +-----+ AL:055 U: 32k clock board fault or not connected +-----+

Carel reserves the right to modify or change its products without prior warning.

CAREL

Technology & Evolution

CAREL S.p.A.

Via dell'Industria, 11 - 35020 Brugine - Padova (Italy)

Tel. (+39) 049.9716611 Fax (+39) 049.9716600

<http://www.carel.com> - e-mail: carel@carel.com

Agency:

Cod: +030221411 rel. 4.112 - 13/02/02